

Catálogo Ferragens



BASSO PANCOTTE

Produtos para Agropecuária

Centro de Distribuição Basso Pancotte

Nova Alvorada/RS



BASSO PANCOTTE

Produtos para Agropecuária

0800 724 1170

bassopancotte.com.br

Centro de Distribuição Cambé/PR



Centro de Distribuição Vespasiano/MG



Somos a Basso Pancotte, uma distribuidora de produtos voltados para o agronegócio, nossa atividade vai além do comércio e está voltada na geração de resultados para nossos clientes e consumidores.

Em mais de 30 anos de trajetória, sempre tivemos em mente o compromisso em atender nosso cliente de forma customizada e correta, entendemos perfeitamente que é isto que nos mantém no mercado e nos dá força para continuar a crescer.



BASSO PANCOTTE

Produtos para Agropecuária

Sumário

Ferramentas manuais.....	4
Cercamento.....	12
Equipamentos para agricultura.....	20
Ferramentas para agricultura.....	45
Lubrificantes.....	56
Coberturas.....	58
Silagem.....	59
Ferragens.....	62
Jardinagem.....	68
Camping.....	75
Pecuária.....	86
Equipamentos veterinários.....	110
Animais de companhia.....	131
Utilidades domésticas.....	137
Piscina.....	162
Construção civil.....	166
Domissanitários.....	187



BASSO PANCOTTE

Produtos para Agropecuária

Ferramentas manuais



Código	Descrição	Cx.
23660	BALANCA PEIXEIRA 12 KG	120
23661	BALANCA PEIXEIRA 20 KG	120



Código	Descrição	Cx.
5379	BALANCA PRATO TORMEN 30/35 KG	1



Código	Descrição	Cx.
24540	BALANCA DPESO CAUDURO ROMANA 300 KG (FUMEIRA) C/AFER	1



Código	Descrição	Cx.
4407	COPO CALIBRADOR CAP. 1.000 ML	40



Código	Descrição	Cx.
24290	MINI BALANCA 125G	12



Código	Descrição	Cx.
5746	BALANCA VARA TORMEN 100 KG	1
23327	BALANCA VARA TORMEN 150 KG	1
5682	BALANCA VARA TORMEN 200 KG	1
5380	BALANCA VARA TORMEN 250 KG	1
26608	BALANCA VARA TORMEN 300 KG	1
6477	BALANCA VARA TORMEN 400 KG	1



Código	Descrição	Cx.
26048	TORNO DE BANCADA NO 02 MOTOMIL	1
26049	TORNO DE BANCADA NO 03 MOTOMIL	1
26050	TORNO DE BANCADA NO 04 MOTOMIL	1
26051	TORNO DE BANCADA NO 05 MOTOMIL	1
26052	TORNO DE BANCADA NO 06 MOTOMIL	1



Código	Descrição	Cx.
27506	CAIXA FERRAMENTAS 20 X 40 METASUL	6



Código	Descrição	Cx.
32372	CAIXA PLASTICA 4030 20" POLYMER	6
32566	CAIXA PLASTICA 4035 20" POLYMER 2 ESTOJO TAMPA	6



Código	Descrição	Cx.
37535	CAIXA PLASTICA 4038 16" POLYMER	6
37536	CAIXA PLASTICA 4041 16" POLYMER	6



Código	Descrição	Cx.
32375	CAIXA PLASTICA 4045 14" POLYMER	6



Código	Descrição	Cx.
32374	CAIXA PLASTICA 4051 14" POLYMER ANTIGA	9
32373	CAIXA PLASTICA 4052 14" POLYMER ANTIGA	9



BASSO PANCOTTE

Produtos para Agropecuária

Ferramentas manuais



Código	Descrição	Cx.
22937	REBOLO MOTO ESMERIL LCWMEDIO CARBOR.	10



Código	Descrição	Cx.
2060	ALICATE TIPO FORD 8" CABO ISOL. BASPAN BJT053	60



Código	Descrição	Cx.
2121	ALICATE AÇO CROMO P/ BOMBA DE ÁGUA BASPAN RP028	60



Código	Descrição	Cx.
2138	ALICATE BICO CHATADO "6" AÇO CARB. BASPAN RP013	36



Código	Descrição	Cx.
2066	ALICATE BICO CURVO 6" AÇO CARB. BASPAN BJT072	60



Código	Descrição	Cx.
2069	ALICATE CORTE DIAG.6" AÇO CARB. BASPAN BJT080	60



Código	Descrição	Cx.
2065	ALICATE TRAM. COR. DIAG 41.006/106	60



Código	Descrição	Cx.
2135	ALICATE DE BICO MEIA CANA 6" AÇO CARB. BASPAN RP011	36



Código	Descrição	Cx.
2109	ALICATE DE BICO MEIA CANA 6" BASPAN BJT 064	60



Código	Descrição	Cx.
2137	ALICATE DE CORTE DIAGONAL "6" AÇO CARB BASPAN RP010	36



Código	Descrição	Cx.
2133	ALICATE DE PRESSÃO "10" AÇO CARB. BASPAN RP024	36



Código	Descrição	Cx.
2134	ALICATE UNIVERSAL 8" AÇO CARB. BASPAN RP009	36



BASSO PANCOTTE

Produtos para Agropecuária

Ferramentas manuais



Código	Descrição	Cx.
2063	ALICATE UNIVERSAL 8", AÇO CARB. BASPAN BJT 058	48



Código	Descrição	Cx.
2059	CHAVE AJUSTAVEL 10" AÇO CARB. BASPAN BJT050	48



Código	Descrição	Cx.
2122	CHAVE INGLESA "10" AÇO CARB. BASPAN RP034	40



Código	Descrição	Cx.
2070	TESOURA CORTA VERGALHÃO 12" BASPAN BJT254	16



Código	Descrição	Cx.
26745	ALICATE FAZENDEIRO 10" TRAMONTINA 41013/110	6



Código	Descrição	Cx.
23782	ALICATE TRAM P/CANOS 41065/109	1



Código	Descrição	Cx.
1134	ALICATE TRAM.8" BICO MEIA CANA 41008/180	12



Código	Descrição	Cx.
5220	ALICATE TRAM.COR.DIAG 41006/106	12



Código	Descrição	Cx.
1922	ALICATE TRAM.ISOL.1000 V "8" 41001/108	12



Código	Descrição	Cx.
1207	CORTA VERGALHAO TRAM 18" 41072/018	1



Código	Descrição	Cx.
32269	ARCO DE PUA C/ CATRACA IRWIN	3

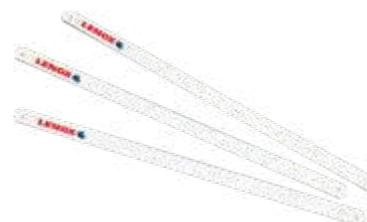

Código	Descrição	Cx.
29366	LAMINA DE SERRA FERRO FLEX.IRWIN C/ 10 UN	1



BASSO PANCOTTE

Produtos para Agropecuária

Ferramentas manuais



Código	Descrição	Cx.
4297	ARCO DE SERRA METASUL C/1 SERRA	12



Código	Descrição	Cx.
1005	ARCO DE SERRA TRAM 43301/012 FIXO	12



Código	Descrição	Cx.
2174	JOGO CHAVE FIXA ESTRELA 8PC BASPAN RP002	12



Código	Descrição	Cx.
2288	CHAVE COMBINADA 06 MM BASPAN RP001	72
2290	CHAVE COMBINADA 07 MM BASPAN RP001	72
2302	CHAVE COMBINADA 08 MM BASPAN RP001	72
2304	CHAVE COMBINADA 09 MM BASPAN RP001	72
2322	CHAVE COMBINADA 12MM BASPAN RP001	72
2326	CHAVE COMBINADA 13MM BASPAN RP001	72
2327	CHAVE COMBINADA 14MM BASPAN RP001	72

Código	Descrição	Cx.
2357	CHAVE COMBINADA 15MM BASPAN RP001	36
2366	CHAVE COMBINADA 16MM BASPAN RP001	36
2367	CHAVE COMBINADA 17MM BASPAN RP001	36
2373	CHAVE COMBINADA 18MM BASPAN RP001	36
2374	CHAVE COMBINADA 19MM BASPAN RP001	36
2375	CHAVE COMBINADA 20MM BASPAN RP001	36
2376	CHAVE COMBINADA 21MM BASPAN RP001	36
2377	CHAVE COMBINADA 22MM BASPAN RP001	36
2378	CHAVE COMBINADA 23MM BASPAN RP001	36
2379	CHAVE COMBINADA 24MM BASPAN RP001	36
2380	CHAVE COMBINADA 25MM BASPAN RP001	36
2381	CHAVE COMBINADA 26MM BASPAN RP001	36
2382	CHAVE COMBINADA 27MM BASPAN RP001	36
2383	CHAVE COMBINADA 28MM BASPAN RP001	36
2384	CHAVE COMBINADA 29MM BASPAN RP001	36
2385	CHAVE COMBINADA 30MM BASPAN RP001	36
2386	CHAVE COMBINADA 32MM BASPAN RP001	36



Código	Descrição	Cx.
2141	JOGO CHAVES COMBINADAS 8PC BASPAN	24



Código	Descrição	Cx.
2173	JOGO CHAVES COMBINADAS 15PC BASPAN RP001	8



Código	Descrição	Cx.
1103	CHAVE BIELA 8 MM 42805/108	6
1104	CHAVE BIELA 9 MM 42805/109	6
1105	CHAVE BIELA 10 MM 42805/110	6
1107	CHAVE BIELA 11 MM 42805/111	6
1109	CHAVE BIELA 12 MM 42805/112	6
4158	CHAVE BIELA 13 MM 42805/113	6
1110	CHAVE BIELA 14 MM 42805/114	6
4159	CHAVE BIELA 15 MM 42805/115	6
1118	CHAVE BIELA 16 MM 42805/116	6
1124	CHAVE BIELA 18 MM 42805/118	6
1126	CHAVE BIELA 19 MM 42805/119	6



Código	Descrição	Cx.
1175	CHAVE COMBINADA C/ PESCOÇO 08 MM	12
1176	CHAVE COMBINADA C/ PESCOÇO 09 MM	12
1180	CHAVE COMBINADA C/ PESCOÇO 10 MM	12
1177	CHAVE COMBINADA C/ PESCOÇO 11 MM	12
1184	CHAVE COMBINADA C/ PESCOÇO 12 MM	12
1188	CHAVE COMBINADA C/ PESCOÇO 13 MM	12
1195	CHAVE COMBINADA C/ PESCOÇO 14 MM	12
1201	CHAVE COMBINADA C/ PESCOÇO 15 MM	12
1204	CHAVE COMBINADA C/ PESCOÇO 16 MM	6
1205	CHAVE COMBINADA C/ PESCOÇO 17 MM	6
1206	CHAVE COMBINADA C/ PESCOÇO 19 MM	6



Código	Descrição	Cx.
3389	CHAVE COMBINADA 24 MM 42246/124	6
3390	CHAVE COMBINADA 25 MM 42246/125	6
3391	CHAVE COMBINADA 26 MM 42246/126	6
3392	CHAVE COMBINADA 27 MM 42246/127	6
3393	CHAVE COMBINADA 28 MM 42246/128	6
3414	CHAVE COMBINADA 30 MM 42246/130	6
3415	CHAVE COMBINADA 32 MM 42246/132	6
27556	CHAVE COMBINADA 34 MM 44660/134	6
27555	CHAVE COMBINADA 36 MM 44660/136	6

Código	Descrição	Cx.
3394	CHAVE COMBINADA 06 MM 42246/106	12
3395	CHAVE COMBINADA 07 MM 42246/107	12
3396	CHAVE COMBINADA 08 MM 41128/108	12
3397	CHAVE COMBINADA 09 MM 41128/109	12
3398	CHAVE COMBINADA 10 MM 41128/110	12
3399	CHAVE COMBINADA 11 MM 41128/111	12
3400	CHAVE COMBINADA 12 MM 41128/112	12
3401	CHAVE COMBINADA 13 MM 41128/113	12
3402	CHAVE COMBINADA 14 MM 41128/114	12
3403	CHAVE COMBINADA 15 MM 41128/115	12
3404	CHAVE COMBINADA 16 MM 41128/116	1
3405	CHAVE COMBINADA 17 MM 41128/117	6
3406	CHAVE COMBINADA 18 MM 42246/118	6
3407	CHAVE COMBINADA 19 MM 41128/119	6
3408	CHAVE COMBINADA 20 MM 42246/120	60
3386	CHAVE COMBINADA 21 MM 42246/121	6
3387	CHAVE COMBINADA 22 MM 42246/122	6
3388	CHAVE COMBINADA 23 MM 42246/123	6



Código	Descrição	Cx.
26584	CHAVE DE RODA 17 MM 42830/117 TRAMO	6



BASSO PANCOTTE

Produtos para Agropecuária

Ferramentas manuais



Código	Descrição	Cx.
1563	CHAVE FIXA BOCA 10X11MM 41120/103 T	12
1564	CHAVE FIXA BOCA 12X13MM 41120/104 T	12
1565	CHAVE FIXA BOCA 14X15MM 41120/105 T	12
1566	CHAVE FIXA BOCA 16X17MM 42006/106 T	6
1567	CHAVE FIXA BOCA 18X19MM 42006/107 T	6
1568	CHAVE FIXA BOCA 20X22MM 42006/108 T	6
5264	CHAVE FIXA BOCA 21X23MM 42006/109 T	6
5265	CHAVE FIXA BOCA 24X26MM 42006/110 T	6
5267	CHAVE FIXA BOCA 27X32MM 42006/112 T	1
1132	CHAVE FIXA BOCA 6X7MM 41120/101 T	12



Código	Descrição	Cx.
22646	CHAVE FENDA 1/4 X 5" TRAMONTINA	12
5260	CHAVE FENDA 1/4 X 6" TRAMONTINA	12
1009	CHAVE FENDA 1/4 X 8" TRAMONTINA	12
22644	CHAVE FENDA 1/8 X 3" TRAMONTINA	12
23855	CHAVE FENDA 1/8 X 4" TRAMONTINA	12
22645	CHAVE FENDA 1/8 X 5" TRAMONTINA	12
5202	CHAVE FENDA 3/16 X 4" TRAMONTINA	12
1008	CHAVE FENDA 3/16 X 5" TRAMONTINA	12
22647	CHAVE FENDA 3/8 X 8" TRAMONTINA	6
5261	CHAVE FENDA 5/16 X 8" TRAMONTINA	6



Código	Descrição	Cx.
22651	CHAVE FENDA PHILIPS 1/4X 6" TRAMONTINA	12
34021	CHAVE FENDA PHILIPS 1/4X 8" TRAMONTINA	12
22648	CHAVE FENDA PHILIPS 1/8X 3" TRAMONTINA	12
22649	CHAVE FENDA PHILIPS 1/8X 5" TRAMONTINA	12
5201	CHAVE FENDA PHILIPS 3/16X 4" TRAMONTINA	12
31914	CHAVE FENDA PHILIPS 3/16X 6" TRAMONTINA	12
22650	CHAVE FENDA PHILIPS 5/16X 6" TRAMONTINA	6



Código	Descrição	Cx.
1477	CHAVE TESTE 1/8 X 3" 41900/110 TRAM	12



Código	Descrição	Cx.
22834	JOGO CHAVE COMB.10 PC 42241/210 TRAMONTINA	6



Código	Descrição	Cx.
28126	JOGO CHAVE HEX. ALEN 5 PCS 44400/505 TRAM	6



Código	Descrição	Cx.
26117	JOGO CHAVES FENDA 6 PECAS TRAM 41516/507	6



Código	Descrição	Cx.
35571	JOGO SOQUETE 1/2 TRAM 43600/022 22 PCS	3



Código	Descrição	Cx.
1864	TESOURA FUNILEIRO BASPAN 250MM- 10' 60011004B	36



Código	Descrição	Cx.
466	FURAD. ELET TRAMON 1/2 500W 220 V 42360/020	10



Código	Descrição	Cx.
467	LAVA JATO TRAM 42552/022 1800W 220V	1
471	LAVA JATO TRAM 42554/012 2100W 127V	1
468	LAVA JATO TRAM 42554/022 2100W 220V	1



Código	Descrição	Cx.
1782	LIMA CHATA K & F 8" S/C 08994D	120



BASSO PANCOTTE

Produtos para Agropecuária

Ferramentas manuais



Código	Descrição	Cx.
1784	LIMA CHATA NICHOLSON 8" S/C 08994E	120



Código	Descrição	Cx.
2639	LIMA P/ENXADA NICHOLSON 8" C/CABO 8990BC ENCARTELADA	12



Código	Descrição	Cx.
525	LIMA P/ENXADA TRAM. 8" S/C 41702/908 C/12 UNID.	1



Código	Descrição	Cx.
33813	LIMA MOTOS NICH. 8 C/12 UNID. MEDIA	25
33392	LIMA MOTOS NICH. 8 C/12 UNID. FINA	25
33393	LIMA MOTOS NICH. 8 C/12 UNID. GROSSA	25



Código	Descrição	Cx.
28562	LIMA TRIANG NICHOLSON 4" C/CABO ENCART	12
28563	LIMA TRIANG NICHOLSON 4,1/2" C/CABO ENCART	12
28564	LIMA TRIANG NICHOLSON 5" C/CABO ENCART	12
28565	LIMA TRIANG NICHOLSON 6" C/CABO ENCART	60



Código	Descrição	Cx.
2854	MARRETA QUADR S/C N°3 PANDOLFO R. 02330	2
2856	MARRETA QUADR S/C N°5 PANDOLFO R. 02350	2



Código	Descrição	Cx.
26640	MARRETA OITAVADA C/C 1 KG PARABONI	1
26642	MARRETA OITAVADA C/C 2 KG PARABONI	3



Código	Descrição	Cx.
2127	MARTELO CABO DE AÇO 24MM BASPAN RP104	36



Código	Descrição	Cx.
2072	MARTELO UNHA 24MM AÇO CARB C/ MADEIRA	24
2232	MARTELO UNHA 28MM AÇO CARB C/ MADEIRA	24



Código	Descrição	Cx.
38441	MARTELO BORRACHA 80 MM PARABONI	6



Código	Descrição	Cx.
250	MARTELO CABO INJETADO. 750G PARABONI	6



Código	Descrição	Cx.
25864	MARTELO CARPINTE. 710G PARABONI	6



BASSO PANCOTTE

Produtos para Agropecuária

Ferramentas manuais



Código	Descrição	Cx.
29596	MARTELO PEDREIRO 500GR 40456/018 TRAM	12



Código	Descrição	Cx.
29595	MARTELO PENA 100GR 40440/002 TRAM	12



Código	Descrição	Cx.
5711	MARTELO TRAM 23MM 40370/023 UNHA	12
5197	MARTELO TRAM 25MM 40370/025 UNHA	12
5198	MARTELO TRAM 27MM 40370/027 UNHA	12



Código	Descrição	Cx.
1106	PE DE CABRA PANDOLFO 50CM	12



Código	Descrição	Cx.
787	PE DE CABRA PARABONI 50CM	3



Código	Descrição	Cx.
26314	PE DE CABRA SAO ROMAO 50 CM	6
26589	PE DE CABRA SAO ROMAO 60 CM	6



Código	Descrição	Cx.
52	SERROTE BASPAN CONSTRUTOR 20" BP 8062	1



Código	Descrição	Cx.
50	SERROTE BASPAN CONSTRUTOR 20" BP 8060	1



Código	Descrição	Cx.
48	SERROTE CARPINTEIRO 22" BASPAN BP 8067	1



Código	Descrição	Cx.
77	SERROTE DE PODA C/ GANCHO BASPAN 14' 355MM BP 8056	1



Código	Descrição	Cx.
82	SERROTE DE PODA CURVO 380MM BASPAN BP 8057	1



Código	Descrição	Cx.
70	SERROTE DE PODA DOBRAVEL BP 8011 BASPAN	1



BASSO PANCOTTE

Produtos para Agropecuária

Ferramentas manuais



Código	Descrição	Cx.
65	SERROTE PODA C/MADEIRA BASPAN 12' 300MM BP 8045	1



Código	Descrição	Cx.
49	SERROTE PROFESSIONAL BASPAN MAX 18" BP 9010	1



Código	Descrição	Cx.
28602	SERROTE PARABONI 20"PROF DENTE GRANDE	3
36643	SERROTE PARABONI 22"PROF DENTES GRANDES	3



Código	Descrição	Cx.
23109	SERROTE TRAM 20" 5 D PROFIS. 43242/020	6



Código	Descrição	Cx.
29603	SERROTE TRAM 13" C/C TELESCOPICO 3 MT 78382/781	1



Código	Descrição	Cx.
6053	SERROTE TRAM DOBRAVEL 78370/401	6



Código	Descrição	Cx.
29602	SERROTE TRAM P/GALHOS ALT 78382/701 PODA	6



Código	Descrição	Cx.
29263	TORQUES TRAM. CARPINTEIRO 10" 41050/110	12



Código	Descrição	Cx.
26308	TORQUES ARMADOR 10 " SAO ROMAO	12
26309	TORQUES ARMADOR 12 " SAO ROMAO	12
26527	TORQUES ARMADOR 14" SAO ROMAO	12



Código	Descrição	Cx.
5222	TORQUES TRAM. ARMADOR 12 " 41053/112	12



Código	Descrição	Cx.
8643	TALHADEIRA CHATA 1/4"X 1x 10" REF. 1783	12



BASSO PANCOTTE

Produtos para Agropecuária

Cercamento



Código	Descrição	Cx.
34118	CHAVE DE ARAMAR (P/EMENDAR ARAME) BASPAN	1



Código	Descrição	Cx.
1999	ACOFIX BALANCIM 3,40 MM FECHER COM 100	1



Código	Descrição	Cx.
3094	GRAMPO 1 X 9 GALVAN CX 20 KG BELGO	1
3054	GRAMPO 1 X 9 POLIDO CX 20 KG BELGO	1



Código	Descrição	Cx.
9503	GRAMPO TRAMBELHO 12 X 7/8 GALVAN 20KG	1
9109	GRAMPO TRAMBELHO 12 X 7/8 POLIDO 20 KG	1



Código	Descrição	Cx.
1939	CATRACA C/ROSETA ESTICAR ARAME "CINFER"	50



Código	Descrição	Cx.
1941	CHAVE P/ CATRACA C/ ROSETA CINFER	1



Código	Descrição	Cx.
4591	ESTICADOR P/CORDALHA 350 MM X 1/2" CINFER	50



Código	Descrição	Cx.
23740	CATRACA P/ESTICAR ARAME G.S. C/10 UNID. PACOTE	10



Código	Descrição	Cx.
23318	MORDENTE CONICO P/ ESTIC. DE ARAME C/1 UNID	50



Código	Descrição	Cx.
22574	ESTICADOR ARAME BP	1



Código	Descrição	Cx.
2967	ESTICADOR ARAME ELIO FERNANDES	1



BASSO PANCOTTE

Produtos para Agropecuária

Cercamento



Código	Descrição	Cx.
1998	ARAME FARP. MOTTO MUNDIAL 250 M	1
1997	ARAME FARP. MOTTO MUNDIAL 500 M	1



Código	Descrição	Cx.
24847	ARAME FARP. RODEIO 250 M	1
24834	ARAME FARP. RODEIO 500 M	1



Código	Descrição	Cx.
2505	ARAME GALVAN. NO 12 (10X1KG) 2,76	1
2004	ARAME GALVAN. NO 14 (10X1KG) 2,10	1
2003	ARAME GALVAN. NO 16 (10X1KG) 1,65	1
2005	ARAME GALVAN. NO 18 (10X1KG) 1,24	1
2008	ARAME GALVAN. NO 20 (10X1 KG) 0,89	1
2006	ARAME GALVAN. NO 22 (10X1 KG) 0,71	1



Código	Descrição	Cx.
6125	ARAME GALVAN. NO 6 INDUSTRIAL 5,15	1
6124	ARAME GALVAN. NO 8 INDUSTRIAL 4,19	1
2503	ARAME GALVAN. NO 12 INDUSTRIAL 2,76	1
2285	ARAME GALVAN. NO 14 INDUSTRIAL 2,10	1
2286	ARAME GALVAN. NO 16 INDUSTRIAL 1,65	1
2287	ARAME GALVAN. NO 18 INDUSTRIAL 1,24	1



Código	Descrição	Cx.
2671	ARAME OVALADO BELGO Z-600 1.250 M	1



Código	Descrição	Cx.
2733	ARAME OVALADO BELGO Z-700 1.000 M	1
24676	ARAME OVALADO BELGO Z-700 500 M	1



Código	Descrição	Cx.
10910	ARAME FORT OVALADO BELGO 1000 M	1



Código	Descrição	Cx.
6679	ARAME GALVAN. FRUTIFIO 1.000M	1



Código	Descrição	Cx.
37323	ARAME GALVAN. CULT. AEREAS 500 M GERDAU	1



Código	Descrição	Cx.
5429	ARAME CERCA ELETR. ELETRIX 500 M	1
6299	ARAME CERCA ELETR. ELETRIX 1000 M	1



Código	Descrição	Cx.
924	TELA CAMPESTRE 120/10/20 50M	1



Código	Descrição	Cx.
22866	TELA HEXAG. P/GALI 2" X 22 X 1,50 X 50 M	1
4140	TELA HEXAG. P/GALI 2"X18 X1,50 X 50 M	1



BASSO PANCOTTE

Produtos para Agropecuária

Cercamento



Código	Descrição	Cx.
2289	TELA HEXAG. P/MANG 3X16X0,80X50 M	1
4141	TELA HEXAG. P/MANG 3X16X1,00X50 M	1
2291	TELA HEXAG. P/MANG 3X16X1,20X50 M	1
4142	TELA HEXAG. P/MANG 3X16X1,50X50 M	1



Código	Descrição	Cx.
4139	TELA HEXAG. P/PINTEI 1X22X1,00X50 M	1
5708	TELA HEXAG. P/PINTEI 1X22X1,50X50 M	1



Código	Descrição	Cx.
4136	TELA HEXAG. P/VIV. 1/2X24X0,80X50 M	1
4137	TELA HEXAG. P/VIV. 1/2X24X1,00X50 M	1
4138	TELA HEXAG. P/VIV. 1/2X24X1,50X50 M	1



Código	Descrição	Cx.
5458	TELA PRATICA 2"x6" 2,03X25M 2,30MM GALV.	1
5418	TELA PRATICA 2"x6"1,02X25M 2,30MM GALV.	1
5428	TELA PRATICA 2"x6"1,22X25M 2,30MM GALV.	1
5454	TELA PRATICA 2"x6"1,52X25M 2,30MM GALV.	1

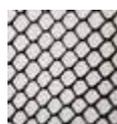

Código	Descrição	Cx.
35652	TELA PLAST GALIN.2"x1,00M X 50M NORTENE	1
3634	TELA PLAST GALIN.2"x1,50M X 50M NORTENE	1



Código	Descrição	Cx.
2030	TELA PLAST GALINH LEVE 2X1,5M X 50M NORT	1
2027	TELA PLAST GALINH LEVE 2X1M X 50M NORT	1



Código	Descrição	Cx.
3636	TELA PLAST PINTEIRO 1"x1,5MX50M NORTENE	1
3635	TELA PLAST PINTEIRO 1"x1M X 50M NORTENE	1



Código	Descrição	Cx.
2018	TELA PLAST PINTEIRO LEVE 1"x1,5M X 50M	1
2019	TELA PLAST PINTEIRO LEVE 1"x1M X 50M	1

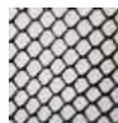

Código	Descrição	Cx.
23098	TELA PLAST VIVEIRO 1/2" 1,5M X 50M NORTENE	1
4378	TELA PLAST VIVEIRO 1/2"x1M X 50M NORTENE	1



Código	Descrição	Cx.
35544	TELA SOMBRE. 50% 1,5 MT X 50 MT NOVA PLAST	1
35546	TELA SOMBRE. 50% 3,0 MT X 50 MT NOVA PLAST	1
35545	TELA SOMBRE. 70% 1,5 MT X 50 MT NOVA PLAST	1
35547	TELA SOMBRE. 70% 3,0 MT X 50 MT NOVA PLAST	1



Código	Descrição	Cx.
5052	TELA SOMBREAM. 30% 1,5MT X 50 MT	1
26755	TELA SOMBREAM. 30% 3,0 MT X 50 MT	1
1905	TELA SOMBREAM. 50% 1,5 MT X 50 MT	1
25795	TELA SOMBREAM. 50% 3,0 MT X 50 MT	1
22957	TELA SOMBREAM. 70% 1,5 MT X 50 MT	1
27875	TELA SOMBREAM. 70% 3,0 MT X 50 MT	1



Código	Descrição	Cx.
27685	TELA SOMB.(SACO.BATATINHA) 50% 1,5M X 50M	1
27686	TELA SOMB.(SACO.BATATINHA) 50% 3M X 50 M	1



BASSO PANCOTTE

Produtos para Agropecuária

Cercamento



Código	Descrição	Cx.
2015	TELA PLAST VIVEIRO LEVE 1/2"X1,5M X 50M	1
2014	TELA PLAST VIVEIRO LEVE 1/2"X1M X 50M	1



Código	Descrição	Cx.
22925	PORTEIRA ELETRICA COMPLETA ZEBU	1



Código	Descrição	Cx.
23704	TERMINAL PORTEIRA PUNHO C/MOLA ZEBU	1



Código	Descrição	Cx.
36129	VOLTIMETRO ANALOGICO ZEBU CERCA ELETRICA	1



Código	Descrição	Cx.
9192	ELETRIFICADOR RURAL 30 KM BATERIA S/REG FAZENDEIRO	24



Código	Descrição	Cx.
10209	ELETRIFICADOR RURAL 30 KM BIVOLT C/REG	24



Código	Descrição	Cx.
9191	ELETRIFICADOR RURAL 30 KM BIVOLT S/REG	24



Código	Descrição	Cx.
10210	ELETRIFICADOR RURAL 50 KM BIVOLT C/REG	24
9193	ELETRIFICADOR RURAL 50 KM BIVOLT S/REG	24



Código	Descrição	Cx.
6302	ELETRIF. ZEBU 127V 2TT3 LUZ C/REGU.	50
391	ELETRIF. ZEBU 220V 2TT3 LUZ C/REGU.	1



Código	Descrição	Cx.
3000	ELETRIF. ZEBU 127V PPCR LUZ	1
2999	ELETRIF. ZEBU 220V PPCR LUZ	1



Código	Descrição	Cx.
2559	ELETRIF. ZEBU 220V ZK200 Alto Poder 200KM	1



BASSO PANCOTTE

Produtos para Agropecuária

Cercamento



Código	Descrição	Cx.
32699	ELETRIF. ZEBU 220V LB80 (LUZ/BAT) 80KM	1



Código	Descrição	Cx.
36235	ELETRIF. ZEBU LB35 LUZ/BATERIA (BIVOLT)	1



Código	Descrição	Cx.
26137	ELETRIF. ZEBU 220V ZK50 50KM	50



Código	Descrição	Cx.
2980	ELETRIF. ZEBU 2TT3 LUZ C/REGU. AUT BIVOLT	1



Código	Descrição	Cx.
10423	ELETRIF. ZEBU PL35 PILHA E LUZ aut 127 e 220V BIV	1



Código	Descrição	Cx.
10422	ELETRIF. ZEBU SR aut 127 e 220V BIV	1



Código	Descrição	Cx.
9166	ELETRIF. ZEBU ZK80 AUTOMAC 127V E 220V BIV 80KM	1



Código	Descrição	Cx.
2565	ELETRIF. ZEBU ZKB50 Alto Poder 50KM BIVOLT/BATERIA	1



Código	Descrição	Cx.
10799	FIO CERCA ELETROPLA. BASPAN 250m (32 Fios)	18
10798	FIO CERCA ELETROPLA. BASPAN 500m (32 Fios)	18



Código	Descrição	Cx.
34507	FIO CERCA ELETRO. BASPAN CLASSICO 250 m	32
34508	FIO CERCA ELETRO. BASPAN CLASSICO 500 m	18

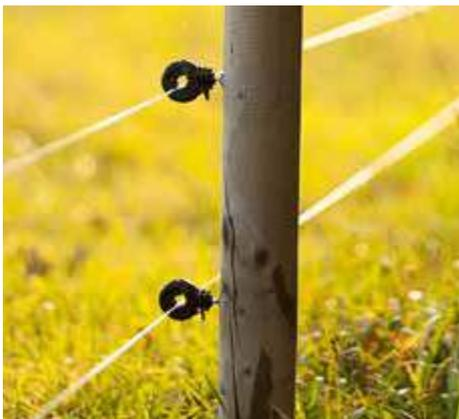

Código	Descrição	Cx.
9814	FIO CERCA ELETROPLA. BASPAN FORTE 250 m	32
9813	FIO CERCA ELETROPLA. BASPAN FORTE 500 m	18



BASSO PANCOTTE

Produtos para Agropecuária

Cercamento



Código	Descrição	Cx.
3695	FIO CERCA ELETROPLA. BASPAN BASICO 250 m	32
3732	FIO CERCA ELETROPLA. BASPAN BASICO 500 m	18



Código	Descrição	Cx.
34509	CINTA ELETROPLASTICA BASPAN FITA 12MM X 200M	16



Código	Descrição	Cx.
37426	CARRETEL FIO ELETROP VAZIO AZUL ZEBU	1



Código	Descrição	Cx.
35886	CHAVE DE CORTE ELETRECIDADE SMI-636	1



Código	Descrição	Cx.
38138	ROLDANA ISOL.24X24 C/100 (CINZA) BASPAN	15
38140	ROLDANA ISOL.30X30 C/100 (CINZA) BASPAN	12
3026	ROLDANA ISOL.36X36 C/50 (CINZA) BASPAN	10



Código	Descrição	Cx.
10628	ROLDANA ISOL.24X24 C/25 und CINZA BASPAN	20
10629	ROLDANA ISOL.30X30 C/25 und CINZA BASPAN	20
10630	ROLDANA ISOL.36X36 C/25 und CINZA BASPAN	1



Código	Descrição	Cx.
8791	ROLDANA ISOL.30X30 C/100 (AMARELO)	12
8792	ROLDANA ISOL.36X36 C/50 (AMARELO)	10



Código	Descrição	Cx.
3030	ROLDANA ISOL.48X48 C/30 (CINZA) BASPAN S/PREGO	1



Código	Descrição	Cx.
3943	ISOLADOR GANCHO CURTO C/25 UNID. BASPAN	20



Código	Descrição	Cx.
3979	ISOLADOR GANCHO LONGO C/25 UNID. BASPAN	1



Código	Descrição	Cx.
3982	ISOLADOR ROLDANA GARRA 40X40 C/100 UNID. BASPAN	10



BASSO PANCOTTE

Produtos para Agropecuária

Cercamento



Código	Descrição	Cx.
3983	ISOLADOR VERGALHAO C/20 UNID. BASPAN	20



Código	Descrição	Cx.
11839	ISOLADOR W AMARELO C/25 UNID. BASPAN	1



Código	Descrição	Cx.
3986	TERMINAL PARA PORTEIRA BASPAN	40



Código	Descrição	Cx.
3985	TERMINAL PARA PORTEIRA MOLA 6m BASPAN	20



Código	Descrição	Cx.
37597	ISOLADOR CASTANHA C/50 UNID. PRETO BASPAN	20



Código	Descrição	Cx.
37596	ISOLADOR W C/50 UNID. PRETO BASPAN	20



Código	Descrição	Cx.
24698	CATRACA P/ESTICAR E ISOLAR CERCA ELET CINFER	48



Código	Descrição	Cx.
23705	ISOLADOR CASTANHA C/20 UNID. ZEBU "DE CANTO"	50



Código	Descrição	Cx.
23722	ISOLADOR GANCHO "ANEL" C/20 UNID. PACOTE ZEBU	50



Código	Descrição	Cx.
23706	ISOLADOR GUIA VERGALHAO C/20 UNID. ZEBU	25



Código	Descrição	Cx.
23703	ISOLADOR W ZEBU C/20 UNID. PACOTE	50



Código	Descrição	Cx.
12176	PALAN CERCA ELET 0,95M C/10 UNID AMARELA	1
3668	PALAN CERCA ELET 0,95M C/10 UNID CINZA	1



Eletrificador Rural 30km

Modelo: ECRF30MDBivolt
Tensão: 127 - 220V~ 60Hz
Potência nominal: 0,3 - 1,4W
Energia acumulada: 0,19J



Eletrificador Rural 50km

Modelo: ECRF50MDBivolt
Tensão: 127 - 220V~ 60Hz
Potência nominal: 0,75 - 2,5W
Energia acumulada: 0,60J



Eletrificador Rural 30km com ajuste de frequência

Modelo: ECRFC30
Tensão: 127 - 220V~ 60Hz
Potência nominal: 0,3 - 1,4W
Energia acumulada: 0,19J



Eletrificador Rural 50km com ajuste de frequência

Modelo: ECRFC50
Tensão: 127 - 220V~ 60Hz
Potência nominal: 0,75 - 2,5W
Energia acumulada: 0,60J



Eletrificador Rural 30km para bateria

Modelo: ECRF30MD12BAT
Tensão: 12V=
Potência nominal: 0,036W
Energia acumulada: 0,16J



Repelente Eletrônico

Modelo: REF30
Entrada: 127 - 220V~ 60 Hz
Consumo: 0,001 kWh
Área de cobertura: 30 m²



Ebulidor Elétrico Agro "Mergulhão"

Modelo: EEF2000 - 127V
EEF2000 - 220V
Tensão: 127 V~ 60 Hz
220 V~ 60 Hz
220 V~ 60 Hz
Potência: 2000 W
Consumo: 2 kWh



Mochador Elétrico

Modelo: MEF240 - 127V
MEF240 - 220V
Tensão: 127V~ 60 Hz
220V~ 60 Hz
Potência: 240 W
Consumo 0,4 kWh
Resistência até 140°C



Auto Transformador de Alumínio

Modelo: ATM750 Potência nominal: 750VA
ATM1010 1010VA
ATM1500 1500VA
ATM2000 2000VA
Tensão: Converte 127V~ em 220V~ 60Hz
Converte 220V~ em 127V~ 60Hz



NOVO Acendedor de Churrasqueira

Modelo: ACF650-127 Tensão: 127V~ 60Hz
ACF650-220 220V~ 60Hz
Potência nominal: 650W
Consumo: 0,6 kWh
Material: Inox



Ebulidor Elétrico de Água Curto e Longo

Modelo: EEFC1000-127 Tensão: 127V~ 60Hz
EEFC1000-220 220V~ 60Hz
EEL1000-127 127V~ 60Hz
EEL1000-220 220V~ 60Hz
Potência nominal: 1000W
Consumo: 1 kWh
Material: Alumínio



Ebulidor Elétrico Garrafa Térmica

Modelo: EECH500-127 Tensão: 127V~ 60Hz
EECH500-220 220V~ 60Hz
Potência nominal: 500W
Consumo: 0,5 kWh
Material: Alumínio



Auto Transformador de Alumínio 3000VA

Modelo: ATM3000 Potência nominal: 3000VA
Tensão: Converte 127V~ em 220V~ 60Hz
Converte 220V~ em 127V~ 60Hz



Carregador de Bateria 12V 1A

Modelo: CFE10
Tensão de entrada: Bivolt
Tensão de saída: 12V =
Potência nominal: 170W





BASSO PANCOTTE

Produtos para Agropecuária

Equipamentos para agricultura



Código	Descrição	Cx.
1396	ACUMUL. K4756 COMPLETEO 20E16 L SIMETR. GUARANY	1



Código	Descrição	Cx.
27440	ACUMUL K-4755 COMPLETEO PLASTICO (PULV.10 LT)	20



Código	Descrição	Cx.
2572	ACUMUL. K4671 SIMETRICO 16E20 L GUARANY	1



Código	Descrição	Cx.
2575	ALAVANCA GUARANY 20 E 16 L K-9689 C/ 1	15



Código	Descrição	Cx.
1398	ASSENTO DE VEDACAO K9320 C/6 PECAS	1



Código	Descrição	Cx.
1479	BARRA UNIVERSAL 2 BICOS 200 MM	6
1559	BARRA UNIVERSAL 2 BICOS 400 MM	6



Código	Descrição	Cx.
35409	BIELA COMPLETA K-8110 GUARANY	1



Código	Descrição	Cx.
24863	BOMBA COMPL.GUARANY K-4474 PULV 4,7 L E 7,6L	1



Código	Descrição	Cx.
3373	BOMBA COMPLETA K-9980 TROMBONE	1



Código	Descrição	Cx.
26465	BOMBA COMPLETA PCP 1,25 L K 4630	10



Código	Descrição	Cx.
5181	BUCHA POLVILHADEIRA 70MM C/10 K3509	1



BASSO PANCOTTE

Produtos para Agropecuária

Equipamentos para agricultura



Código	Descrição	Cx.
22820	BUCHA DUPLA EKOMAX C/10 K-6120	1



Código	Descrição	Cx.
1399	BUCHA DUPLA K3707 C/10 PUL. 20/16 L	1



Código	Descrição	Cx.
34843	CHASSI GUARANY 7583 (NOVO)	1



Código	Descrição	Cx.
5168	CILINDRO BOMBA K5080 C/2 PULV 5 L	24



Código	Descrição	Cx.
22822	CILINDRO PLASTICO K-6116 (10 e 20 LT) EKOMAX	1



Código	Descrição	Cx.
26729	CILINDRO PLASTICO U-5007 S-20 L [SIMETRICO]	1



Código	Descrição	Cx.
24821	CONJ. TUBO PESCADOR EKO II K 4752	24



Código	Descrição	Cx.
28009	CONJ DESC.COMPLET. K-4653 PULV 10 L	1



Código	Descrição	Cx.
2556	CONJ DESC.COMPLET. K-9537 VALVULA C/ DESCARGA	1



Código	Descrição	Cx.
2576	CORREIA SUST 20/16 L K-4445 C/1 GUARANY	24



Código	Descrição	Cx.
29503	FILTRO DO CILINDRO EKOMAX K-6312 C/10 UNID	1



Código	Descrição	Cx.
1425	FILTRO DO PISTAO COMPLETO K1135 C/2	1



BASSO PANCOTTE

Produtos para Agropecuária

Equipamentos para agricultura



Código	Descrição	Cx.
1404	GAXETA DE PLASTICO K1649 C/ 4	24



Código	Descrição	Cx.
2583	GRAMPO FIXADOR DA CORREIA K1139 C/4	1



Código	Descrição	Cx.
5162	HASTE ACIONAM COMPLETA K-4268	24



Código	Descrição	Cx.
35716	HASTE DA BOMBA COMPLETA 1,25 K 4629	1



Código	Descrição	Cx.
5146	HASTE DE ACIONAMENTO (PCA3-20) - U6217	25



Código	Descrição	Cx.
24864	KIT REP GUARANY K-4613 PULV 4,7 L PREVIA	12



Código	Descrição	Cx.
27891	KIT REP K-4460 EKOMAX PULMAO PLASTICO	1



Código	Descrição	Cx.
26464	KIT REP. GUARANY 1,25 L K 4628	1



Código	Descrição	Cx.
2961	KIT REP.K-56 COD.4452 GUARANY SIMETRICO 20 L C/1	12



Código	Descrição	Cx.
2554	KIT REP.K58 K 4536 GUARANY 5 L C/1	1



Código	Descrição	Cx.
26846	KIT REPARO VALVULA S-5 4605	1



Código	Descrição	Cx.
27009	MANG. COMPLETA PET U.4182	6



BASSO PANCOTTE

Produtos para Agropecuária

Equipamentos para agricultura



Código	Descrição	Cx.
27161	MANGUEIRA COM CONEXAO E PESCADOR K-4753	1



Código	Descrição	Cx.
1426	MANGUEIRA O INT. 5/16 X 1300 K-4427 SIMT.20LT	1



Código	Descrição	Cx.
5159	MANGUEIRA 5 L TROMBONE K-5895	12



Código	Descrição	Cx.
5151	O-RING BUNA OINT.15,54 K1644 C/10PC	20



Código	Descrição	Cx.
5180	O-RING BUNA OINT.18,72 K2809 C/2 PECAS	20



Código	Descrição	Cx.
27171	O-RING BUNA OINT.45,69 K6215 C/6 PECAS	20



Código	Descrição	Cx.
5166	O-RING VITON FLUORO ELAST.K1181 C/2	1



Código	Descrição	Cx.
5165	O-RING VITON K1180 C/5 UN .PULV 5L FLUORO-ELAST	1

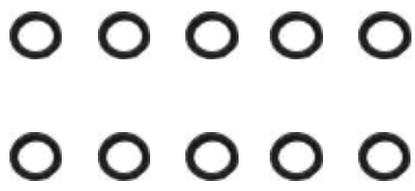

Código	Descrição	Cx.
5174	O-RING BUNA OINT.6,07 C/10 K1455	20



Código	Descrição	Cx.
27172	PISTAO COMPLETO U9968 GUARANY PUL SIM. 20 L	1



Código	Descrição	Cx.
5161	PONTA ANTI-GOTEJAMENTO K-4196	1



Código	Descrição	Cx.
1429	PONTA CONE REGULAVEL K 8118 1,2 MM	1



BASSO PANCOTTE

Produtos para Agropecuária

Equipamentos para agricultura



Código	Descrição	Cx.
32188	PONTA DEFL 0,75 VERDE K5746.12 C/12 PC	1
32186	PONTA DEFL 1,0 AMARELO K5619.12 C/12 PC	1
32189	PONTA DEFL 2,0 VERMELHA K5374.12 C/12 PC	1
32191	PONTA DEFL 3,0 CINZA K2253.12 C/12 PC	1
32192	PONTA DEFL 4,0 BRANCO K5375.12 C/12 PC	1



Código	Descrição	Cx.
32165	PONTA STAND 1,5 VERDE K5722 C/12 PC	1
32166	PONTA STAND 2,0 AMARELO K5588 C/12 PC	1
32167	PONTA STAND 4,0 VERMELHO K5589 C/12 PC	1



Código	Descrição	Cx.
1512	PORCA ALOJAMENTO GAXETA K1089 C/ 2	1

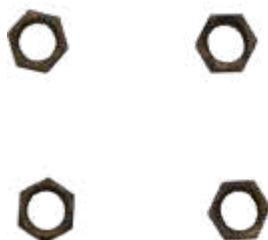

Código	Descrição	Cx.
25749	PORCA DA BIELA C/04 "SIMETR." K1029	20



Código	Descrição	Cx.
1560	PORCA DA BIELA K6131 PLASTICA C/ 6	1



Código	Descrição	Cx.
1514	PORCA DA BUCHA K3656 C/ 10	24



Código	Descrição	Cx.
1428	PORCA DO BICO NYLON K3441 C/ 4	1



Código	Descrição	Cx.
5353	TAMPA DO TANQUE C/VALV.4276-PCA2-20	6



Código	Descrição	Cx.
1423	TUBO DE DESCARGA 20 LT CURVO 525 MM - 9119	1



Código	Descrição	Cx.
26847	TUBO DE DESCARGA COMPLETO PCA 10 LT 4646	1



Código	Descrição	Cx.
9783	TUBO DE DESCARGA CURVO 1,2 MT K 4280.00 C/6und	1



Código	Descrição	Cx.
26463	VALVULA DE SEGURANCA PCP 4,6 LT K.4521	1



BASSO PANCOTTE

Produtos para Agropecuária

Equipamentos para agricultura



Código	Descrição	Cx.
5324	VALVULA DESCARGA S-3 SIMETRICO 4320	1



Código	Descrição	Cx.
26845	VALVULA DESCARGA S-5 EKOMAX 4604	1



Código	Descrição	Cx.
1515	VALVULA INFERIOR DA BOMBA K4278 C/6	24



Código	Descrição	Cx.
3033	VALVULA SEMI ESFERICA K-5066 C/ 10	1



Código	Descrição	Cx.
1511	CAPA FURO 1,2 MM PULV 5 L	1



Código	Descrição	Cx.
22819	CHASSI TIPO SAPATA C/2 K-6088 EKOMAX	24



Código	Descrição	Cx.
1513	GUARNICAO DA TAMPA K1128 C/ 2	24



Código	Descrição	Cx.
5184	GUARNICAO (FURMIGAO 1L) C/20 K5563	24



Código	Descrição	Cx.
24617	HASTE DO CILINDRO P-2G	24



Código	Descrição	Cx.
9828	PROTECTOR TIPO CHAPEU NAPOLEAO PRETO	12



Código	Descrição	Cx.
25657	ADUBADEIRA REF. "130 D" DUPLA ZINCADA KRUPP	2



Código	Descrição	Cx.
2926	ADUBADEIRA REF. "13AA" INOX KRUPP	4



BASSO PANCOTTE

Produtos para Agropecuária

Equipamentos para agricultura



Código	Descrição	Cx.
2927	ADUBADEIRA REF. "13AAZ" ZINCADA KRUPP	4



Código	Descrição	Cx.
4502	ADUBADEIRA REF. 13AAZ-D (DUPLA) KRUPP	2



Código	Descrição	Cx.
4558	MAQUINA FUMO BICO RED. KRUPP REF 135R	4



Código	Descrição	Cx.
410	PLANT. ADUB. KRUPP 13-A INOX	2



Código	Descrição	Cx.
411	PLANT. ADUB. KRUPP 13-AZ ZINCADA	2



Código	Descrição	Cx.
9181	PLANT. ADUB. KRUPP 166-A INOX BICO DUPLO	2



Código	Descrição	Cx.
9182	PLANT. ADUB. KRUPP 166-AZ BICO DUPLO	2



Código	Descrição	Cx.
999	PLANT. ADUB. KRUPP 66-A INOX	2



Código	Descrição	Cx.
1370	PLANT. ADUB. KRUPP 66-AZ ZINCADA	2



Código	Descrição	Cx.
22875	PLANT. ADUB. KRUPP 102-A C/3 DISCO GRAO/	2
22910	PLANT. ADUB. KRUPP 102-AZ C/3 DISCO GRAO/	2



Código	Descrição	Cx.
1344	PLANT. KRUPP 13 SIMPLES	4



Código	Descrição	Cx.
22874	PLANT. KRUPP 102 GRAO/GRAO C/DISCO	4



BASSO PANCOTTE

Produtos para Agropecuária

Equipamentos para agricultura



Código	Descrição	Cx.
1345	PLANT. KRUPP 103 PLANTIO DIRETO	4



Código	Descrição	Cx.
6066	PLANT. KRUPP 106-A RG FER.PLAN DIRETO	4



Código	Descrição	Cx.
1346	PLANT. KRUPP 106-M PLANT.DIR	4



Código	Descrição	Cx.
24083	PLANT. KRUPP REF 04	4



Código	Descrição	Cx.
27543	PLANT. KRUPP REF 113	4



Código	Descrição	Cx.
8823	PULVERIZADOR PULVEMARK 85 L (SILAGEM)	1



Código	Descrição	Cx.
2114	FIXADOR ELASTICO C/10 UND BASPAN 323105	50

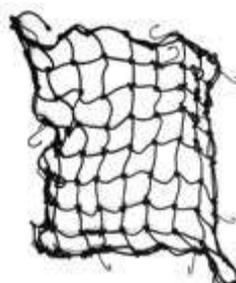

Código	Descrição	Cx.
2113	REDE ELASTICA 60 X 60CM BASPAN 323132	40



Código	Descrição	Cx.
23799	DEBULHADOR MILHO MANUAL 30DMZ.21	2



Código	Descrição	Cx.
23801	ENGENHO PARA CANA MANUAL C/ REG. B60	2



Código	Descrição	Cx.
23463	MOINHO P/CAFE N° 3 BOTIMETAL 20.MPC.03	2



BASSO PANCOTTE

Produtos para Agropecuária

Equipamentos para agricultura



Pulverizadores Leves e Polvilhadeira



PULVERIZADOR ULTRAJET

Cor	Código	Tanque	Emb.
Verde	1030	500ml	12
Laranja	1030	500ml	12



PULVERIZADOR NÉVOA

Cor	Código	Tanque	Emb.
Verde	11763	300ml	12
Laranja	11762	750ml	12



PULVERIZADOR EXPORT

Código	Emb.
1038	12



MATA FORMIGA

Código	Tanque	Emb.
1290	1Kg	01
22698	2Kg	01



tradição
e inovação

Soluções para o seu cultivo!



Pulverizador Costal de Alavanca - 10L



Pulverizador Costal de Alavanca SP - 16 e 20L



Pulverizador Costal de Alavanca SE - 16 e 20L

mais informações em
guaranyind.com.br



☎ 0800 704 4511
✉ sac@guaranyind.com.br



BASSO PANCOTTE

Produtos para Agropecuária

Equipamentos para agricultura



Pulverizador Costal de Alavanca - SP



Código	Tanque	Emb.
675	20ℓ	01

Assista o vídeo sobre o produto!

QR Code - Video

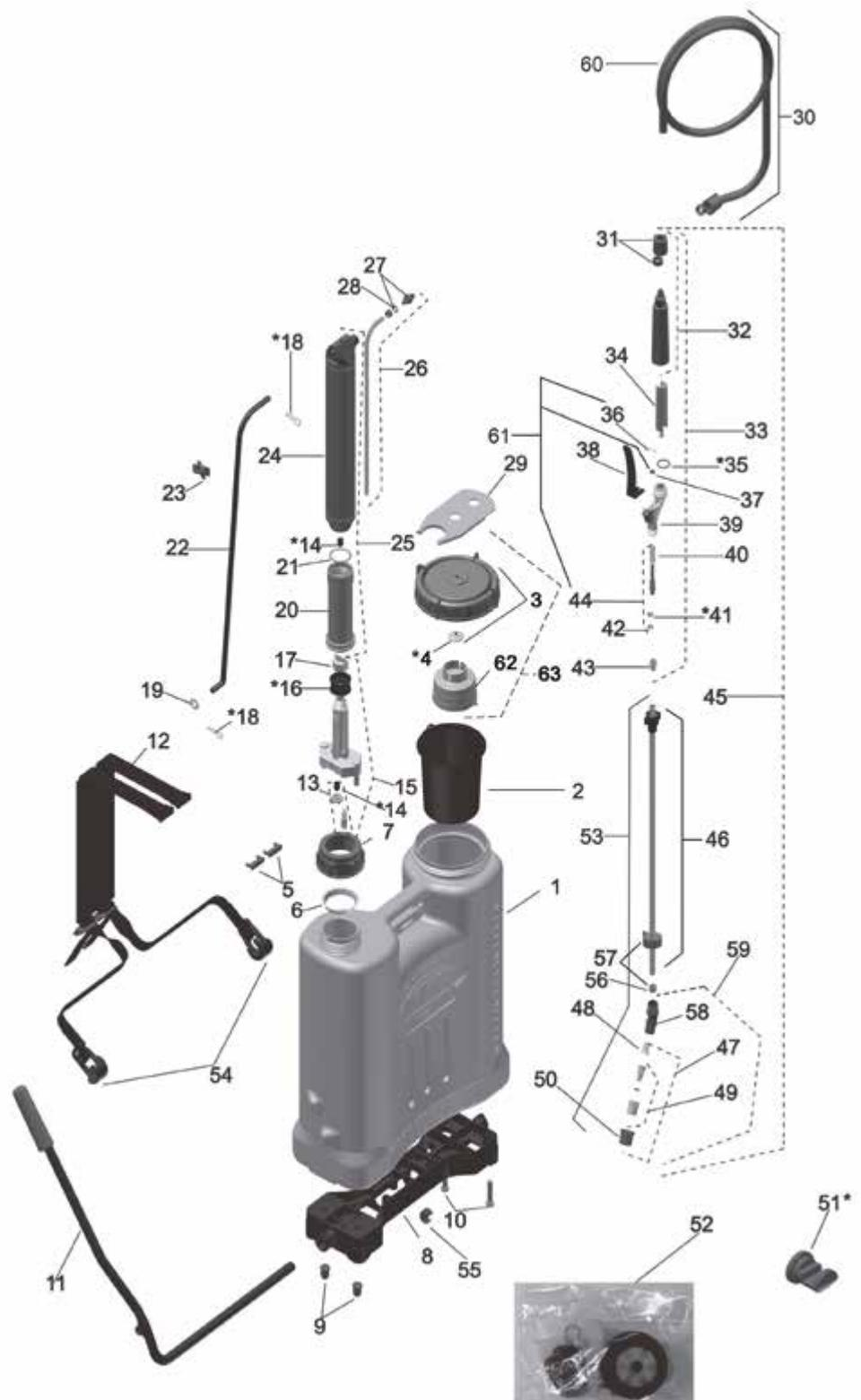



BASSO PANCOTTE

Produtos para Agropecuária

Equipamentos para agricultura



Pulverizador Costal de Alavanca - SP

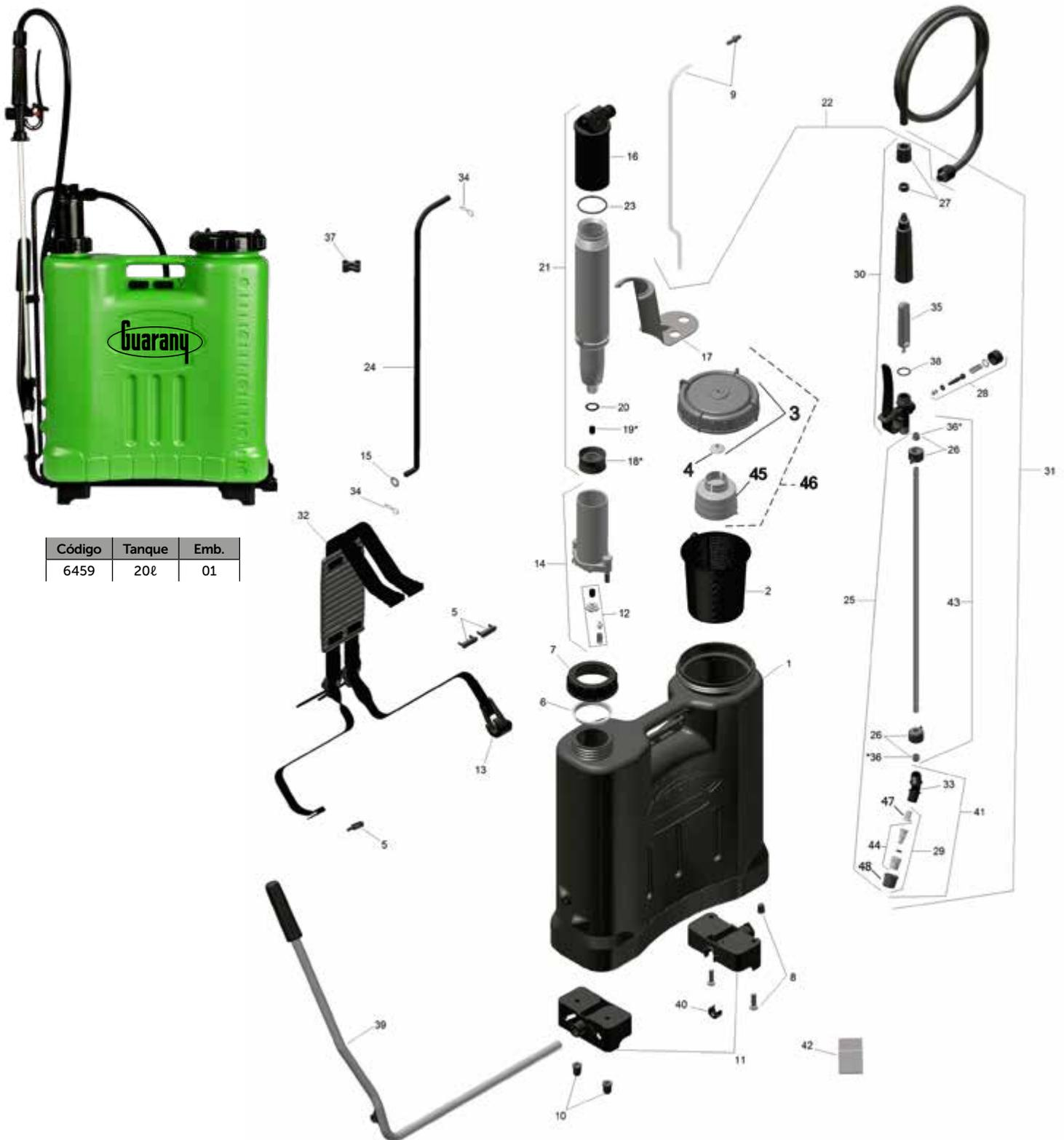

Código	Tanque	Emb.
6459	20ℓ	01

**BASSO PANCOTTE**

Produtos para Agropecuária

Equipamentos para agricultura**Lista de Peças**

ITEM	DESCRIÇÃO	CÓDIGO	ITEM	DESCRIÇÃO	CÓDIGO
1	Tanque químico 20l	-	36	Bucha de fixação do tubo de descarga *	-
	Tanque químico 16l	-	37	Presilha da haste	-
2	Filtro do tanque químico	1517	38	O-ring	-
3	Tampa do tanque com válvula	5353	39	Alavanca "L" com manopla	-
4	Válvula membrana	-	40	Trava da alavanca	-
5	Grampo fixador da correia	2583	41	Ponta curva completa	-
6	Gaxeta de plástico	-	42	Kit de serviço	27891
7	Porca de alojamento da gaxeta	-	43	Tubo de descarga com porca	-
8	Parafuso de fixação do chassi com porca	-	44	Ponta regulável	-
9	Conjunto do tubo pescador	24821	45	Copo dosador	-
10	Porca plástica	-	46	Conjunto tampa completo	-
11	Chassi direito/esquerdo	-	47	Filtro do bico	5144
12	Conjunto de válvulas do cilindro	-	48	Porca	-
13	Fivela de engate rápido	-			
14	Cilindro plástico completo	22822			
15	Arruela lisa	-			
16	Cabeçote	-			
17	Agitador	-			
18	Bucha dupla*	22820			
19	Válvula semi-esférica*	3033			
20	O-ring	5151			
21	Acumulador plástico completo	22821			
22	Mangueira com tubo pescador	27161			
23	O-ring	27171			
24	Haste de acionamento	-			
25	Tubo de descarga completo	-			
26	Porca e bucha de fixação do tubo	-			
27	Porca e bucha de fixação do cabo	-			
28	Kit de reparo da válvula S-5	26846			
29	Ponta regulável completa	1429			
30	Válvula de descarga S-5	26845			
31	Conjunto de descarga completo	2556			
32	Correia de sustentação completa	-			
33	Ponta curva	-			
34	Grampo	-			
35	Filtro	-			



BASSO PANCOTTE

Produtos para Agropecuária

Equipamentos para agricultura



Pulverizador Costal de Alavanca



Código	Tanque	Emb.
25461	10ℓ	01

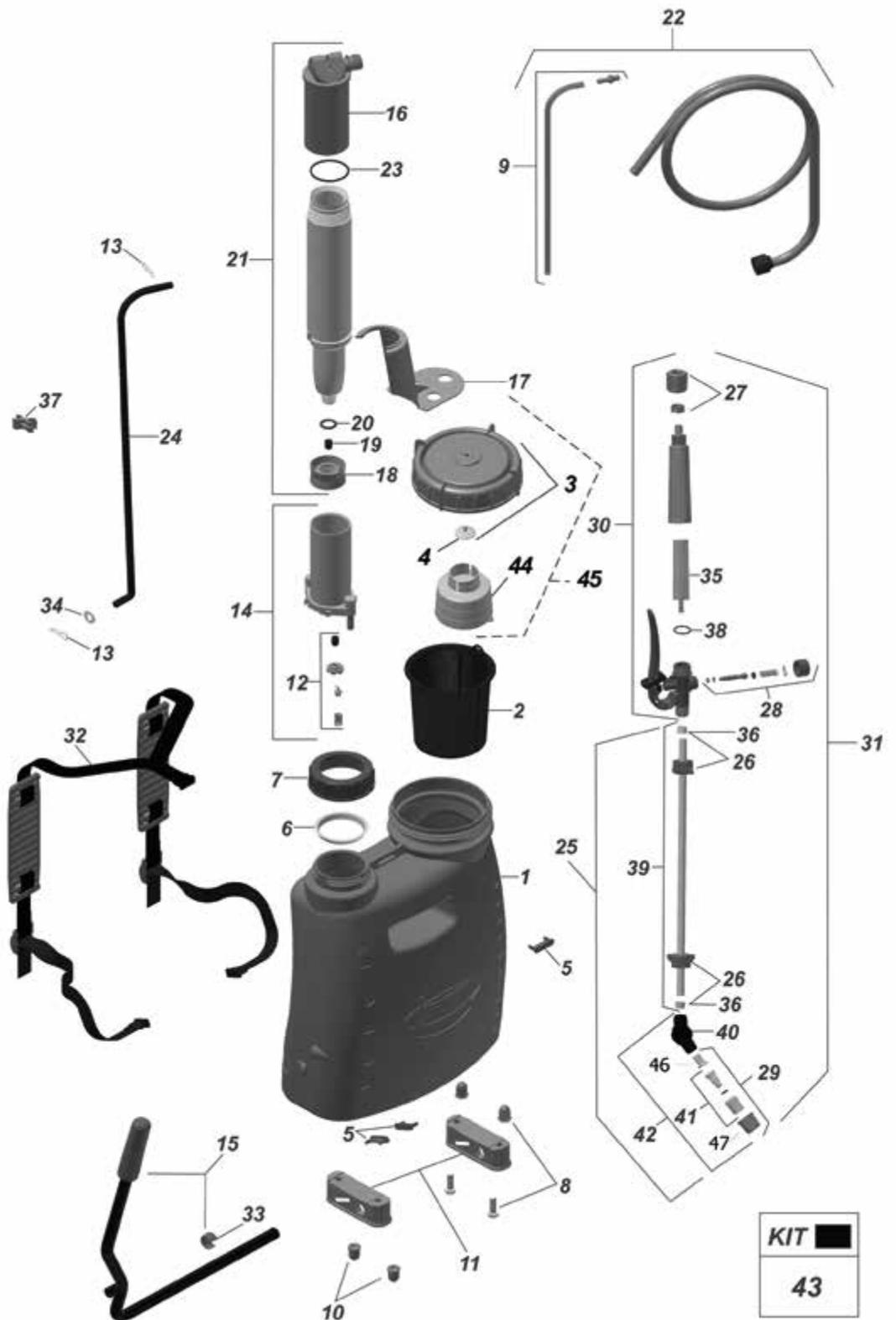

**BASSO PANCOTTE**

Produtos para Agropecuária

Equipamentos para agricultura

Lista de Peças

ITEM	DESCRIÇÃO	CÓDIGO	ITEM	DESCRIÇÃO	CÓDIGO
1	Tanque químico branco	-	36	Bucha de fixação do tubo de descarga	-
	Tanque químico laranja	-	37	Presilha da haste	-
2	Filtro do tanque químico	1517	38	O-ring	-
3	Tampa do tanque com válvula	5353	39	Tubo de descarga com porca	-
4	Válvula membrana	-	40	Ponta curva	-
5	Grampo fixador da correia	2583	41	Ponta regulável	-
6	Gaxeta de plástico	-	42	Ponta curva completa	-
7	Porca do alojamento da gaxeta	-	43	Kit de serviço*	27891
8	Parafuso de fixação do chassi com porca	-	44	Copo dosador	-
9	Conjunto do tubo pescador	-	45	Conjunto tampa completo	-
10	Porca plástica	-	46	Filtro do bico	5144
11	Chassi direito/esquerdo	-	47	Porca	-
12	Conjunto de válvulas do cilindro	-			
13	Grampo	-			
14	Cilindro plástico completo	22822			
15	Alavanca completa em "L" com manopla	-			
16	Cabeçote	-			
17	Agitador	-			
18	Bucha dupla	22820			
19	Válvula semiesférica	3033			
20	O-ring	-			
21	Acumulador plástico completo	27440			
22	Conjunto Mangueira PCA 10l	-			
23	O-ring	27171			
24	Haste de acionamento	-			
25	Tubo de descarga completo	-			
26	Porca e bucha de fixação do tubo	-			
27	Porca e bucha de fixação do cabo	-			
28	Kit de reparo de válvula S-5	26846			
29	Ponta regulável completa	1429			
30	Válvula de descarga S-5	26845			
31	Conjunto de descarga completa	28009			
32	Correia de sustentação	-			
33	Trava da alavanca de acionamento	-			
34	Arruela lisa	-			
35	Filtro	-			

ITEM	DESCRIÇÃO	CÓDIGO
-	Tubo de Descarga Completo	26847

Modelo Antigo do Equipamento

ITEM	DESCRIÇÃO	CÓDIGO
-	Tubo de Descarga Completo	26847



BASSO PANCOTTE

Produtos para Agropecuária

Equipamentos para agricultura



Pulverizador de Compressão Prévia



Código	Tanque	Emb.
24861	1ℓ	01





BASSO PANCOTTE

Produtos para Agropecuária

Equipamentos para agricultura

Lista de Peças

ITEM	DESCRIÇÃO	CÓDIGO
1	Tanque (1,2l)	-
2	Bomba completa	26465
3	Haste da bomba completa	35716
4	Alavanca de acionamento	-
5	Guarnição (O-ring) da bomba	-
6	Válvula da bomba	-
7	Agulha completa	-
8	O-ring do êmbolo	-
9	Capa com pastilha	-
10	Kit de serviço*	26464
11	Capa com helicoide	-



BASSO PANCOTTE

Produtos para Agropecuária

Equipamentos para agricultura



Pulverizador de Compressão Prévia



Código	Tanque	Emb.
24150	4,7ℓ	01

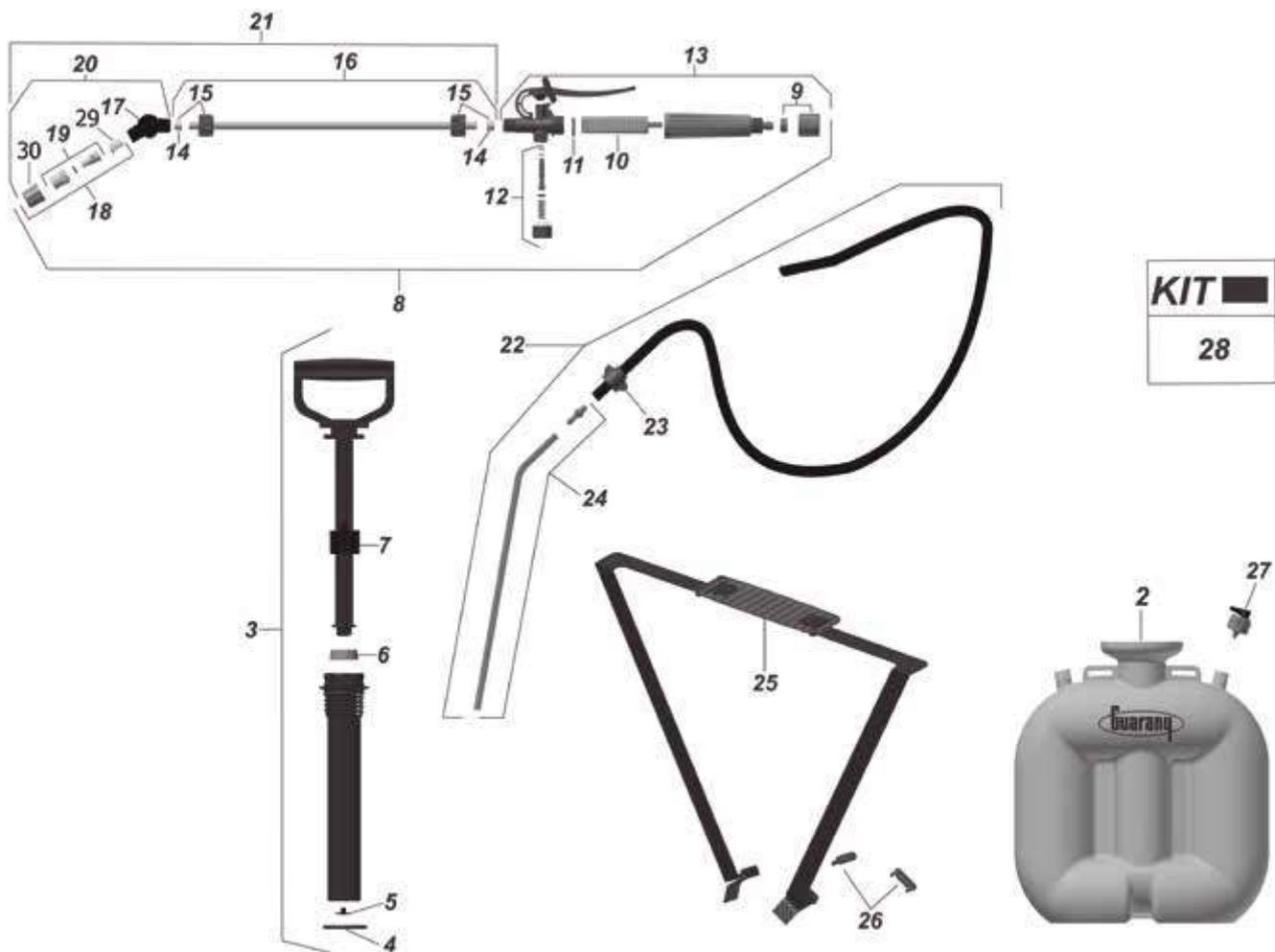



BASSO PANCOTTE

Produtos para Agropecuária

Equipamentos para agricultura

Lista de Peças

ITEM	DESCRIÇÃO	CÓDIGO
1	Tanque (7,6l)	-
2	Tanque (4,7l)	-
3	Bomba completa	24863
4	Guarnição da bomba	-
5	Válvula da bomba	-
6	Bucha da bomba	-
7	Bucha guia do pistão	-
8	Conjunto de descarga completo	-
9	Porca e bucha de fixação do cabo	-
10	Filtro	-
11	O-ring	-
12	Kit de reparo Válvula S-5	26846
13	Válvula de descarga S-5	26845
14	Bucha de fixação do tubo de descarga	-
15	Porca e bucha de fixação do tubo	-
16	Tubo de descarga com porca	-
17	Ponta curva	-
18	Ponta regulável completa	1429
19	Ponta regulável	-
20	Ponta curva completa	-
21	Tubo de descarga completo	-
22	Mangueira com conexão/ sucção 4,7l	-
	Mangueira com conexão/ sucção 7,6l	-
23	Porca do tubo pescador	-
24	Conjunto do tubo pescador 4,7l	-
	Conjunto do tubo pescador 7,6l	-
25	Correia com ombreiras	-
26	Grampo fixador da correia	2583
27	Válvula de segurança completa	26463
28	Kit de serviço	24864
29	Filtro do bico	5144
30	Porca	1428



BASSO PANCOTTE

Produtos para Agropecuária

Equipamentos para agricultura



Pulverizador de Alta Pressão - 5ℓ e PET



Código	Tanque	Emb.
1039	5ℓ	01



Código	Cor	Emb.
1965	Preta	01

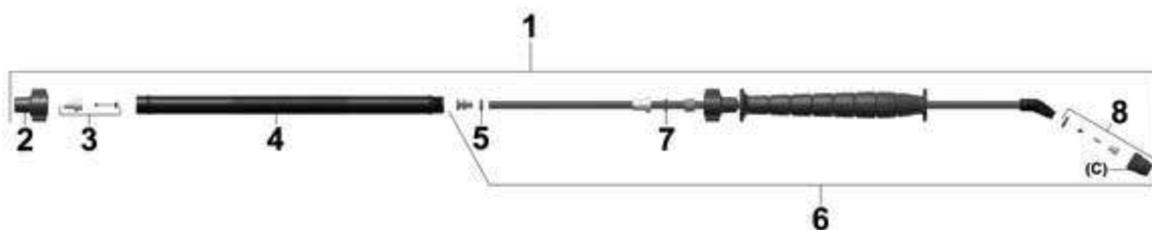



BASSO PANCOTTE

Produtos para Agropecuária

Equipamentos para agricultura

Lista de Peças

ITEM	DESCRIÇÃO	CÓDIGO
1	Bomba completa	3373
2	Porca guia	-
3	Válvula de entrada	-
4	Cilindro de bomba	5168
5	O-ring fluoro-elastômero	5165
6	Haste de acionamento completa	5162
7	O-ring fluoro-elastômero	5166
8	Ponta anti-gotejamento	5161
9	Correia com grampo (PET)	-
10	Mangueira completa (PET)	27009
11	Mangueira (5l)	-
12	Filtro	-
13	Correia com ombreiras	-
14	Tampa do tanque (5l)	-
15	Tanque 5l (laranja)	-
16	Kit de serviço	2554
17	Grampo fixador da correia	2583



BASSO PANCOTTE

Produtos para Agropecuária

Equipamentos para agricultura

Acessórios



BARRA UNIVERSAL - 200mm

Código	Bicos
1479	2



BARRA UNIVERSAL - 400mm

Código	Bicos
1559	2



BARRA UNIVERSAL - 500mm

Código	Bicos
3359	2



BARRA HORIZONTAL TRASEIRA

Código	Bicos
1478	6



LEQUE PLANO STANDARD

Cor	Descrição	Código	Emb.
●	0.2 com ângulo 110°	32166	12
●	0.4 com ângulo 110°	32167	12
●	0.15 com ângulo 110°	32165	12



LEQUE PLANO DEFLETORA

Cor	Descrição	Código	Emb.
●	3.0 com ângulo 110°	32191	12
●	2.0 com ângulo 105°	32189	12
●	2.5 com ângulo 110°	32190	12
●	1.5 com ângulo 105°	32193	12
○	4.0 com ângulo 120°	32192	12
●	1.0 com ângulo 105°	32186	12
●	0.75 com ângulo 95°	32188	12

Informações sobre Assistência Técnica ou Garantia, entre em contato com nosso SAC

0800 - 704 4511 sac@guaranyind.com.br

guaranyind.com.br

Guarany tradição e inovação



BASSO PANCOTTE

Produtos para Agropecuária

Equipamentos para agricultura



Código	Descrição	Cx.
6459	PULV GUARANY 20 L KOMAX	1



Código	Descrição	Cx.
675	PULV GUARANY 20 L SIMETRICO S-3	1



Código	Descrição	Cx.
1038	PULV GUARANY EXPORT 370 ML (FLITZ)	12



Código	Descrição	Cx.
24150	PULV GUARANY COMPRESSAO PREVIA 4,7 L	1



Código	Descrição	Cx.
25461	PULV GUARANY COSTAL ALAV. 10 L	1



Código	Descrição	Cx.
1039	PULV GUARANY 5 L	1



Código	Descrição	Cx.
11763	PULV NEVOA GUARANY 300 ML	12
11762	PULV NEVOA GUARANY 750 ML	12



Código	Descrição	Cx.
1030	PULV ULTRAJET GUARANY 500 ML	12



Código	Descrição	Cx.
24861	PULV GUARANY COMP.PREVIA 1,25 L PCP 1 P	6



Código	Descrição	Cx.
22698	POLV GUARANY PLUS 2 KG POL 2000	4



Código	Descrição	Cx.
1290	POLV GUARANY MATA-FORMIGA PLUS	6



Código	Descrição	Cx.
1965	PULV GUARANY ALTA PRESSAO PET (P/GARRAFA)	2



BASSO PANCOTTE

Produtos para Agropecuária

Equipamentos para agricultura



Código	Descrição	Cx.
23800	TRITURADOR MILHO MANUAL C/CAV 25.TMC20	1



Código	Descrição	Cx.
23860	TRITURADOR MILHO MANUAL S/CAV 25TMS.19	2



Código	Descrição	Cx.
24580	MOSTIMETRO DE BABO 8 + 32 REF.5788	100



Código	Descrição	Cx.
32319	PLUVIOMETRO CRISTAL 150 MM INCOTERM	1



Código	Descrição	Cx.
34205	TERMÔMETRO HIGROMETRO DIGITAL	1



Código	Descrição	Cx.
2612	TERMOMETRO AMB. -10+50:1' TA25.6	1



Código	Descrição	Cx.
24716	TERMOMETRO CLINICO DIGITAL INCOTERM	24



Código	Descrição	Cx.
2613	TERMOMETRO MAX. MIN. -38+50:1'	1



Código	Descrição	Cx.
33653	TERMOMETRO MAX. MIN. DIGITAL 7427	10



Código	Descrição	Cx.
8335	TERMOMETRO P/ CHIMARRAO -10+150 1C: 5042.21	20

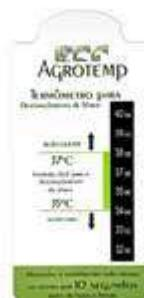

Código	Descrição	Cx.
1210	TERMOMETRO P/ DESCONGELAMENTO DE SEMEN	1



Código	Descrição	Cx.
3929	TERMOMETRO QUIMICO -10+60: 5040.20 (PRODUTOS LIQ)	25



BASSO PANCOTTE

Produtos para Agropecuária

Ferramentas para agricultura



Código	Descrição	Cx.
2802	TERMOMETRO REFRIG.-10+110 GRAU C 5135 LATICINIOS	1



Código	Descrição	Cx.
36798	TERMOMETRO TIPO ESPETO DIGITAL -45 + 230 6132	10



Código	Descrição	Cx.
34162	TERMOMETRO TIPO PISTOLA C/LASER -60+500 ST-600	1



Código	Descrição	Cx.
2611	TERMOMETRO VETERIN.+34+44:0,1 5198.10	1



Código	Descrição	Cx.
10707	PLUVIOMETRO CRISTAL 130 MM SGAMAQ	30



Código	Descrição	Cx.
28099	GRAFITE MADEGRAFITE 25 X 1 KG FARDO	1



Código	Descrição	Cx.
29440	GRAFITE MADEGRAFITE 5 X 5 KG FARDO	1



Código	Descrição	Cx.
4371	AGULHA COSTUR.SACO 01-125MM C/25 UNID. ZINCADA	1



Código	Descrição	Cx.
4238	ALFANGE ESTR NO 22 TRA	6



Código	Descrição	Cx.
12118	CABO BP PA EM " (D PVC) " C/6 UNID.PACOTE	1



Código	Descrição	Cx.
835	CABO BP ENXADA OVAL C/6 UNID. PACOTE 130 CM	1



Código	Descrição	Cx.
2267	CABO BP PA CURVO C/6 UNID. PACOTE 120 CM	1



BASSO PANCOTTE

Produtos para Agropecuária

Ferramentas para agricultura



Código	Descrição	Cx.
1198	CABO ALFANGE METÁLICO VOPER C/PRESILHA	10



Código	Descrição	Cx.
7102	CABO BP MARRETA 77 CM C/6 UNID. PACOTE	1



10 cm

Código	Descrição	Cx.
2272	CABO BP LIMA MADEIRA C/6 UNID. PACOTE	1

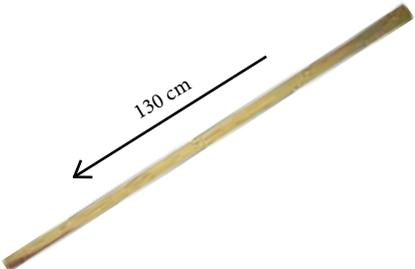

130 cm

Código	Descrição	Cx.
835	CABO BP ENXADA OVAL C/6 UNID. PACOTE	1

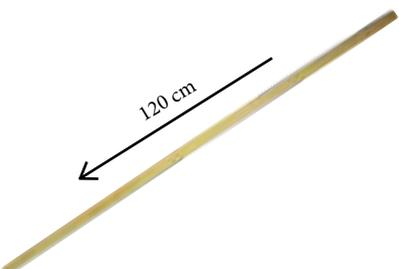

120 cm

Código	Descrição	Cx.
6721	CABO BP RASTEL (ANCINHO) C/6 UNID. PACOTE	1

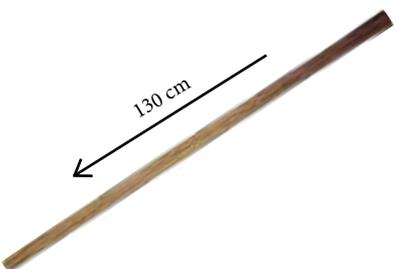

130 cm

Código	Descrição	Cx.
2620	CABO BP ENXADA OLHO REDONDO C/6 UNID.	1

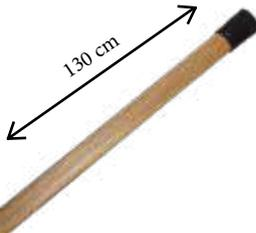

130 cm

Código	Descrição	Cx.
32752	CABO BP ENXADA OVAL C/PONT. PLAS. C/6 UN.	1

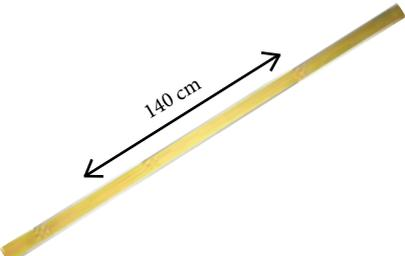

140 cm

Código	Descrição	Cx.
6625	CABO BP CAVADEIRA C/6 UNID. PACOTE	1

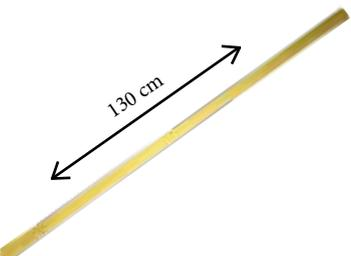

130 cm

Código	Descrição	Cx.
24791	CABO BP ENXADA OLHO DE MARTELO C/6 UN.	1

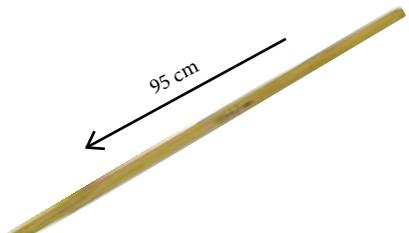

95 cm

Código	Descrição	Cx.
2264	CABO BP FOICE OVAL C/6 UNID. PACOTE	1

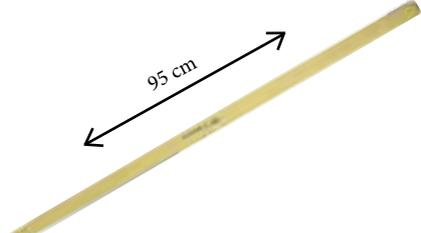

95 cm

Código	Descrição	Cx.
778	CABO BP FOICE REDONDO C/6 UNID. PACOTE	1

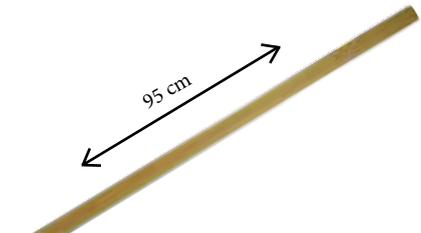

95 cm

Código	Descrição	Cx.
773	CABO BP ENXADA OVAL C/6 UNID. PACOTE	1



BASSO PANCOTTE

Produtos para Agropecuária

Ferramentas para agricultura

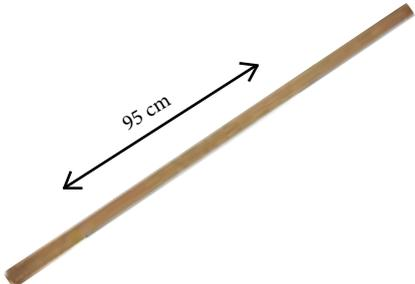

Código	Descrição	Cx.
2261	CABO BP MACHADO C/6 UNID. PACOTE	1

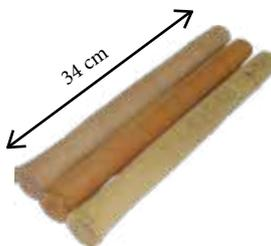

Código	Descrição	Cx.
2271	CABO BP MARTELO 32 CM C/6 UNID. PACOTE	1

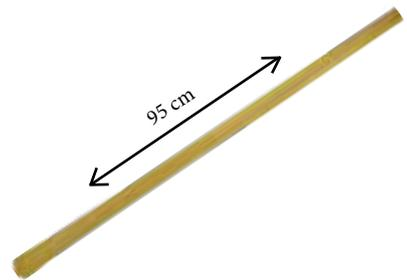

Código	Descrição	Cx.
2270	CABO BP PICARETA C/6 UNID. PACOTE	1

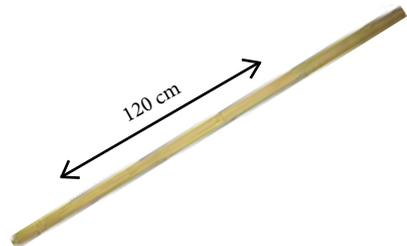

Código	Descrição	Cx.
2266	CABO BP PA RETA C/6 UNID. PACOTE	1

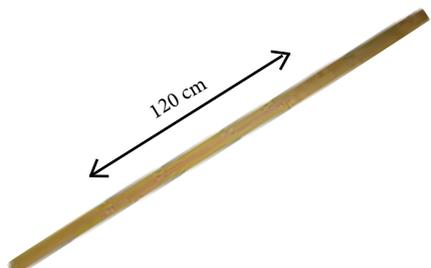

Código	Descrição	Cx.
2267	CABO BP PA CURVO C/6 UNID. PACOTE	1

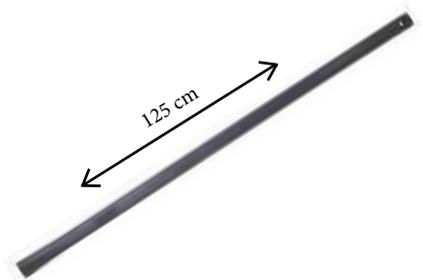

Código	Descrição	Cx.
34819	CABO P/ ENXADA OLHO OVAL C/6 SINT. NORYL	1

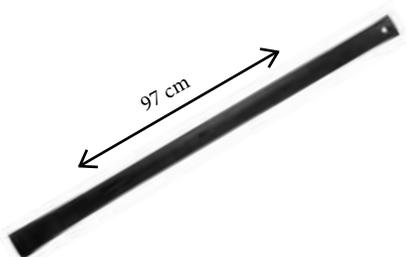

Código	Descrição	Cx.
34289	CABO MACHADO C/3 SINT. NORYL PARABONI	1



Código	Descrição	Cx.
25129	CAVADEIRA FERREIRO RETA	1



Código	Descrição	Cx.
1172	CAVAD. METISA 500-2 C/C MEDIA ARTICULADA	2



Código	Descrição	Cx.
1147	CAVAD. PARABONI SIMPLES RETA C/C	3



Código	Descrição	Cx.
23697	CAVAD TRAM. ARTICULADA 77559/524 C/C	1



Código	Descrição	Cx.
2273	CAVAD PANDOLFO ARTICULADA TUCANO C/ CABO	2



BASSO PANCOTTE

Produtos para Agropecuária

Ferramentas para agricultura



Código	Descrição	Cx.
3870	CAVAD. PANDOLFO ARTICULADA C/CABO	2



Código	Descrição	Cx.
6715	CAVAD. PANDOLFO CORTE GOIVA S/CABO	12



Código	Descrição	Cx.
3015	CAVAD. PANDOLFO CORTE RETA S/CABO	12



Código	Descrição	Cx.
2501	CAVAD. TRAM. RETA S/C 77550/095	6



Código	Descrição	Cx.
25129	CAVAD FERREIRO RETA	1



Código	Descrição	Cx.
2396	CAVAD TRAM. GOIVA S/C	6



Código	Descrição	Cx.
48	CAVADEIRA FERREIRO GOIVA	12



Código	Descrição	Cx.
26118	ENXADA TANE 1 LBS 23,50 CM	6



Código	Descrição	Cx.
26119	ENXADA TANE 1 1/2 LBS 25CM	6



Código	Descrição	Cx.
26120	ENXADA TANE 2 LBS 28 CM	6



Código	Descrição	Cx.
26121	ENXADA TANE. 2 1/2 LBS 30CM	6



Código	Descrição	Cx.
27168	ENXADA FERREIRO C / CABO	1



BASSO PANCOTTE

Produtos para Agropecuária

Ferramentas para agricultura



Código	Descrição	Cx.
5409	ENXADA PANDOLFO C/C OLHO OVAL 946-80	6



Código	Descrição	Cx.
27096	ENXADA PANDOLFO ITALIANA O. OVAL 045-6" S/CABO	12



Código	Descrição	Cx.
24552	ENXADA PANDOLFO OLHO OVAL S/C R.47-75	12



Código	Descrição	Cx.
24554	ENXADA PANDOLFO OLHO RED S/C REF 44-7,5	12



Código	Descrição	Cx.
24553	ENXADA PANDOLFO OVAL S/C REF 04790	12



Código	Descrição	Cx.
2447	ENXADA PANDOLFO PEQUENA C/C REDON REF 75005	6



Código	Descrição	Cx.
1044	ENXADA PANDOLFO S/C OVAL 46-80	12



Código	Descrição	Cx.
24423	ENXADA PANDOLFO S/C RED 44-90	12



Código	Descrição	Cx.
23225	ENXADA PANDOLFO S/C RED REF 05220	12



Código	Descrição	Cx.
23157	ENXADA PANDOLFO S/C RED REF.04280	12



Código	Descrição	Cx.
6435	ENXADA PARABONI OVAL 8" C/CABO	3



Código	Descrição	Cx.
836	ENXADA PARABONI S/C SUL OVAL 8"	6



BASSO PANCOTTE

Produtos para Agropecuária

Ferramentas para agricultura



Código	Descrição	Cx.
4741	ENXADA TRAM S/C OLHO RED	6



Código	Descrição	Cx.
1162	ENXADA TRAM C/C OLHO REDONDO	1



Código	Descrição	Cx.
3466	ENXADA TRAM S/C SUL OVAL	6



Código	Descrição	Cx.
32644	ENXADA TRAM. 77201/654 C/C SUL OVAL	210



Código	Descrição	Cx.
1943	ENXADA TRAM. 77218/204 S/C 22,5 CM OLHO RED.	6



Código	Descrição	Cx.
36681	ENXADAO FERREIRO C/CABO	1



Código	Descrição	Cx.
24557	ENXADAO PANDOLFO 50 C 2,5 S/C LARGO	12



Código	Descrição	Cx.
28339	ENXADAO PANDOLFO C/C OLHO/MACHADO R.96110	6



Código	Descrição	Cx.
3869	ENXADAO PANDOLFO S/C OLHO/MACHADO 6110	12



Código	Descrição	Cx.
23158	ENXO PANDOLFO RETO C/C REF 190	6



Código	Descrição	Cx.
1637	ENXADAO PARABONI S/C OLHO/MACHADO	6



Código	Descrição	Cx.
1153	FACAO TRAM INOX 12"	12



BASSO PANCOTTE

Produtos para Agropecuária

Ferramentas para agricultura



Código	Descrição	Cx.
1140	FACAO TERCADO TRAM 17"	36
1152	FACAO TERCADO TRAM 21"	36



Código	Descrição	Cx.
1638	FACAO TRAM 10"	60
1639	FACAO TRAM 12"	60
1011	FACAO TRAM 14"	60
1091	FACAO TRAM 16"	60
1092	FACAO TRAM 18"	60
1640	FACAO TRAM 20"	60



Código	Descrição	Cx.
1569	FACAO TRAM CANA 12"	60
3035	FACAO TRAM CANA 13"	36



Código	Descrição	Cx.
4553	FACAO TRAM CANA C.LONGO 13"	36



Código	Descrição	Cx.
28975	FACAO TRAM P/ MATO C/ MADEIRA 12"	60
28976	FACAO TRAM P/ MATO C/ MADEIRA 14"	60
28977	FACAO TRAM P/ MATO C/ MADEIRA 16"	60
37171	FACAO TRAM P/ MATO C/ MADEIRA 20"	36



Código	Descrição	Cx.
12103	BAINHA DE COURO P/ FACAO NO 10" AO 20"	1



Código	Descrição	Cx.
25130	FOICE FERREIRO 1/2 LUA S/C	6



Código	Descrição	Cx.
23160	FOICE PANDOLFO 1/2 LUA 39/13 S/C	12



Código	Descrição	Cx.
1027	FOICE PANDOLFO 1/2 LUA 39/15 S/C MATO	12
4599	FOICE PANDOLFO 1/2 LUA 39/16 S/C MATO	12
26235	FOICE PANDOLFO 1/2 LUA 39/25 ESQ S/C MATO	12
5410	FOICE PANDOLFO 1/2 LUA C/CABO MATO	6



Código	Descrição	Cx.
32536	FOICE PANDOLFO BANANA EST DIR. S/C R.01010	12



Código	Descrição	Cx.
23224	FOICE PANDOLFO BANANA S/C 39 B DIREITA	12
26236	FOICE PANDOLFO BANANA S/C 39 B ESQUERDA	12



Código	Descrição	Cx.
23159	FOICE PANDOLFO COQUEIRO S/C REF 89	12



BASSO PANCOTTE

Produtos para Agropecuária

Ferramentas para agricultura



Código	Descrição	Cx.
24556	FOICE PANDOLFO PARANA S/C REF 37 DIREITA	12



Código	Descrição	Cx.
27422	FOICE PANDOLFO STA. CATARINA DIR. S/C	12



Código	Descrição	Cx.
777	FOICE PARABONI 1/2 LUA 10" S/C SUL	6



Código	Descrição	Cx.
2720	FOICE PARABONI SUL 1/2 LUA 9" S/C	6



Código	Descrição	Cx.
1382	FOICINHA PASTO LISA 15"	12
3516	FOICINHA PASTO LISA 25"	12



Código	Descrição	Cx.
3101	FOICINHA SOJA C/C 5" TRAM	12



Código	Descrição	Cx.
1975	FOICINHA TRAM DENTE MEDIA	12



Código	Descrição	Cx.
3935	FOICINHA TRAM DENTE PEQ 77684/305	12



Código	Descrição	Cx.
6110	FORCADO ACO ESP CURVO SILA. 4 D S/C	1
22883	FORCADO ACO ESP CURVO SILA. 6 D S/C	1



Código	Descrição	Cx.
24836	FORCADO ACO ESP RETO 3 D S/C P/SILAGEN	10



Código	Descrição	Cx.
6111	FORCADO ACO ESP RETO SILA. 4 D S/C	1
6112	FORCADO ACO ESP RETO SILA. 6 D S/C	10



Código	Descrição	Cx.
25134	FORCADO ACO ESP. FERREIRO 10 DENTES	10



BASSO PANCOTTE

Produtos para Agropecuária

Ferramentas para agricultura



Código	Descrição	Cx.
6113	FORCADO ACO ESP.VIRAR TERRA S/C	10



Código	Descrição	Cx.
1405	FORCADO PANDOLFO CURVO 4 D S/C	12



Código	Descrição	Cx.
1406	FORCADO PANDOLFO RETO 4 D S/C	12



Código	Descrição	Cx.
775	FORCADO PARABONI CURVO 4 D S/C	6



Código	Descrição	Cx.
774	FORCADO PARABONI RETO 4 D S/C	6



Código	Descrição	Cx.
1869	FORCADO TRAM. CURVO 4 D S/C 77130/044	12



Código	Descrição	Cx.
22576	FORCADO TRAM.10 D C/C 77128/404 CASCALHO	1



Código	Descrição	Cx.
4675	MACHADINHO PANDOLFO CASEIRO C/CABO	12



Código	Descrição	Cx.
26237	MACHADO PANDOLFO 2,5L. S/C	6



Código	Descrição	Cx.
1062	MACHADO PANDOLFO 3,5 LBS MATO S/CABO	6
4600	MACHADO PANDOLFO PARA MATO C/CABO	6



Código	Descrição	Cx.
781	MACHADO PANDOLFO PARA MATO C/CABO	4



Código	Descrição	Cx.
31	MACHADO PARABONI ESCOTEIRO C/CABO NORYL	4



BASSO PANCOTTE

Produtos para Agropecuária

Ferramentas para agricultura



Código	Descrição	Cx.
779	MACHADO PARABONI LENHADOR S/CABO	6



Código	Descrição	Cx.
26312	MACHADINHO MARTELO/UNHA SAO ROMAO	12



Código	Descrição	Cx.
26313	MACHADINHO SAO ROMAO DOMESTICO C/CABO	12



Código	Descrição	Cx.
1139	PA METISA R.102-2 C/C AJUNTAD. FRANK	6
952	PA METISA R.102-2 S/C AJUNTADEIRA	6



Código	Descrição	Cx.
3976	PA METISA R.200-3 S/C QUAD C/ BORDA	6



Código	Descrição	Cx.
953	PA METISA R.201-2 S/C AJUNTAD. BARRO	6



Código	Descrição	Cx.
951	PA METISA R.202-6 S/C P/ CARVAO	6
1187	PA METISA R.202-6P C/C P/ CARVAO	6



Código	Descrição	Cx.
3975	PA METISA R.300-3 S/C DE CORTE BICO	6



Código	Descrição	Cx.
950	PA METISA R.400-3 S/C QUADRADA CORTE	6



Código	Descrição	Cx.
1131	PA METISA R.400-3P C/C QUAD. CORTE	6



Código	Descrição	Cx.
1755	PA PANDOLFO CONCHA D/BICO S/C R.8310	6



Código	Descrição	Cx.
27087	PA PANDOLFO CONCHA QUADRADA S/C R.8320	6



BASSO PANCOTTE

Produtos para Agropecuária

Ferramentas para agricultura



Código	Descrição	Cx.
27458	PA PANDOLFO CORTE D/BICO S/C R.8410	6



Código	Descrição	Cx.
27459	PA PANDOLFO CORTE QUADRADA S/C 8420	6



Código	Descrição	Cx.
10258	PA PARABONI AJUNT C/CABO REF 101136	6



Código	Descrição	Cx.
782	PA PARABONI AJUNT.BICO S/C	6



Código	Descrição	Cx.
34663	PA TRAM AJUNT. C/CABO 77454/504	1



Código	Descrição	Cx.
475	PA TRAM AJUNT. C/CABO Y 77459/434	1



Código	Descrição	Cx.
11826	PA TRAM ALUMINIO. C/CABO Y 77531/426	1



Código	Descrição	Cx.
2688	PA TRAM PLASTICA C/CABO Y 77540/425	1



Código	Descrição	Cx.
1873	PA TRAM. AJUNT. S/C 77454/004 FRANKFUR	6



Código	Descrição	Cx.
3928	PA TRAM. JARDINEIRA 77444/404 C/C	1



Código	Descrição	Cx.
5610	PA TRAM. VANGA QUAD 77400/424 C/C	1



Código	Descrição	Cx.
3098	PA TRAM. VANGA QUADR 77400/024 S/C	6



BASSO PANCOTTE

Produtos para Agropecuária

Lubrificantes



Código	Descrição	Cx.
1064	PICARETA PANDOLFO ESTREITA S/C F. 56	6



Código	Descrição	Cx.
4259	PICARETA PANDOLFO PA LARGA REF. 57	6



Código	Descrição	Cx.
2820	PICARETA PARABONI ALVIAO S/C PA LARGA	6



Código	Descrição	Cx.
26859	PICARETA (ALVIAO) TRAMONTINA 77303/403	6



Código	Descrição	Cx.
2073	ALMOTOLIA METAL. C/ BICO FLEX. 250 ML BASPAN BJT 162	50



Código	Descrição	Cx.
6557	BOMBA DE GRAXA MOD. PIKI 7 KG	2



Código	Descrição	Cx.
6560	FUNIL MOD. 170 RETO USO GERAL	1



Código	Descrição	Cx.
23295	JIMO PENETRIL 400 ML DESENGRIPANTE CX C/6 UND	1



Código	Descrição	Cx.
36031	JIMO PENETRIL AEROSOL 100 ML DESENGRIPANTE CX C/12 UNID.	1



Código	Descrição	Cx.
10571	DESENGRIPANTE MP1 LUB CX 12 X 321ml/193g	1



Código	Descrição	Cx.
28395	WD40 SPRAY 6 X 300ML MULTIUSO LUBRIFICANTE	1



Código	Descrição	Cx.
1754	UNIGRAX CA2 1 KG	12
24474	UNIGRAX CA2 10 KG	1
1745	UNIGRAX CA2 20 KG	1

AGROPLASTIC

Excelência e sustentabilidade em filmes plásticos



LINHA AGRÍCOLA (UV)

LEITOSA:

30% DE TRASLUCIDEZ, PARA CULTIVO DE FLORES E MORANGOS.

TRANSPARENTE: MAIOR LUMINOSIDADE PARA CULTIVO DE HORTALIÇAS.

DIFUSOR: POSSUI MICRO CRISTAIS QUE DIFUNDEM A LUZ, EVITANDO A FORMAÇÃO DE SOMBRAS ENTRE AS PLANTAS.



LINHA FLEX

PRETA, COLORIDA E TRANSPARENTE



LINHA DUPLA FACE

PRETA / BRANCA

FABRICADA ESPECIALMENTE PARA SILAGEM



A AGROPLASTIC É UMA INDÚSTRIA ESPECIALIZADA NO DESENVOLVIMENTO E PRODUÇÃO DE FILMES PLÁSTICOS PARA A AGRICULTURA, CONSTRUÇÃO CIVIL E INDÚSTRIA.

WWW.AGROPLASTIC.COM.BR





BASSO PANCOTTE

Produtos para Agropecuária

Coberturas



Código	Descrição	Cx.
26490	UNILIT BLUE/2 10 KG ROLAMENTO	1
27792	UNILIT BLUE/2 ESPECIAL 1 KG P/ ROLAMENTO	12



Código	Descrição	Cx.
36309	OLEO ORDENHADEIRA 1 L UNIX BVO CX C/ 12 UNID	1



Código	Descrição	Cx.
27067	UNIX CORRENTE MOTOSERRA 1 LITRO	12
1741	UNIX CORRENTE MOTOSERRA 5 LITROS	4



Código	Descrição	Cx.
6370	UNIX DT 200 ML	40
1746	UNIX DT 500 ML	40



Código	Descrição	Cx.
1326	FILME TUBOLON A-UV 2.2 X 100 100 MC	1
24862	FILME TUBOLON A-UV 2.4 X 100 100 MC	1
1223	FILME TUBOLON A-UV 4 X 100 100 MC	1
1793	FILME TUBOLON A-UV 4 X 100 150 MC	1
1222	FILME TUBOLON A-UV 6 X 100 100 MC	1
1787	FILME TUBOLON A-UV 6 X 100 150 MC	1
4037	FILME TUBOLON A-UV 8 X 105 X 100 MC	1
1796	FILME TUBOLON A-UV 8 X 105 X 150 MC	1
1791	FILME TUBOLON A-UV 8 X 55 150 MC	1
8073	FILME TUBOLON A-UV 8 X 55 X 100 MC	1



Código	Descrição	Cx.
23392	LONA FORTE 2 X 2 LARANJA	1
23393	LONA FORTE 3 X 2 LARANJA	1
23394	LONA FORTE 3 X 3 LARANJA	1
23395	LONA FORTE 4 X 3 LARANJA	1
23396	LONA FORTE 4 X 4 LARANJA	1
23397	LONA FORTE 5 X 3 LARANJA	1

Código	Descrição	Cx.
23398	LONA FORTE 5 X 4 LARANJA	1
23399	LONA FORTE 5 X 5 LARANJA	1
23400	LONA FORTE 6 X 3 LARANJA	1
23401	LONA FORTE 6 X 4 LARANJA	1
23402	LONA FORTE 6 X 5 LARANJA	1
23404	LONA FORTE 7 X 4 LARANJA	1
23405	LONA FORTE 7 X 5 LARANJA	1
23407	LONA FORTE 8 X 4 LARANJA	1
23409	LONA FORTE 8 X 6 LARANJA	1
23410	LONA FORTE 9 X 3 LARANJA	1
23411	LONA FORTE 9 X 4 LARANJA	1
23412	LONA FORTE 10 X 4 LARANJA	1
23420	LONA FORTE 10 X 5 LARANJA	1
23413	LONA FORTE 10 X 6 LARANJA	1
23414	LONA FORTE 10 X 8 LARANJA	1
23419	LONA FORTE 12 X 8 LARANJA	1



Código	Descrição	Cx.
3616	LONA CARRET 2X2 AM	18
3617	LONA CARRET 3X2 AM	12
3618	LONA CARRET 3X3 AM	16
3620	LONA CARRET 4X4 AM	10
3621	LONA CARRET 5X3 AM	10
3622	LONA CARRET 5X4 AM	8
3624	LONA CARRET 6X4 AM	6
3625	LONA CARRET 6X5 AM	5



Código	Descrição	Cx.
24933	LONA FORTE 2 X 2 AZUL	1
24934	LONA FORTE 3 X 2 AZUL	1
24935	LONA FORTE 3 X 3 AZUL	1
24936	LONA FORTE 4 X 3 AZUL	1
24937	LONA FORTE 4 X 4 AZUL	1
24938	LONA FORTE 5 X 3 AZUL	1

Código	Descrição	Cx.
24967	LONA FORTE 5 X 4 AZUL	1
24939	LONA FORTE 5 X 5 AZUL	1
24940	LONA FORTE 6 X 3 AZUL	1
24941	LONA FORTE 6 X 4 AZUL	1
24942	LONA FORTE 6 X 5 AZUL	1
24944	LONA FORTE 7 X 4 AZUL	1
24945	LONA FORTE 7 X 5 AZUL	1
24947	LONA FORTE 8 X 4 AZUL	1
24948	LONA FORTE 8 X 6 AZUL	1
24949	LONA FORTE 9 X 3 AZUL	1
24950	LONA FORTE 9 X 4 AZUL	1
24951	LONA FORTE 10 X 4 AZUL	1
24952	LONA FORTE 10 X 5 AZUL	1
24953	LONA FORTE 10 X 6 AZUL	1
24954	LONA FORTE 10 X 8 AZUL	1
24955	LONA FORTE 10 X 9 AZUL	1
24957	LONA FORTE 12 X 7 AZUL	1
24958	LONA FORTE 12 X 8 AZUL	1



Código	Descrição	Cx.
12314	AGROLORD ECOLON 1,60X1000 (MULCHING P/ MORANGO)	1



BASSO PANCOTTE

Produtos para Agropecuária

Silagem



Código	Descrição	Cx.
632	SILO PRETO E BRANCO PLUS 6X50	1
647	SILO PRETO E BRANCO PLUS 10X50	1
9409	SILO PRETO E BRANCO PLUS 12X50	1
642	SILO PRETO E BRANCO PLUS 8X100	1
634	SILO PRETO E BRANCO PLUS 6X100	1
635	SILO PRETO E BRANCO PLUS 8X50	1
6932	SILO PRETO E BRANCO SUPER 10X50	1
6935	SILO PRETO E BRANCO SUPER 6X100	1
6936	SILO PRETO E BRANCO SUPER 6X50	1
6934	SILO PRETO E BRANCO SUPER 8X100	1
6933	SILO PRETO E BRANCO SUPER 8X50	1



Código	Descrição	Cx.
9108	TUBOLON PRETO 4 X 100 X 20	1



Código	Descrição	Cx.
6855	SILO PRETO BPL PLUS 4 X 100 50 KG	1
37224	SILO PRETO BPL PLUS 6 X 100 80 KG	1
37225	SILO PRETO BPL PLUS 6 X 50 40 KG	1
31747	SILO PRETO BPL PLUS 8 X 100 110 KG	1
31749	SILO PRETO BPL PLUS 8 X 50 55 KG	1
28404	SILO PRETO BPL SUPER 4 X 100 40 KG	1
28405	SILO PRETO BPL SUPER 6 X 100 60 KG	1
27381	SILO PRETO BPL SUPER 6 X 50 30 KG	1
28406	SILO PRETO BPL SUPER 8 X 100 80 KG	1
24360	SILO PRETO BPL SUPER 8 X 50 40 KG	1
27380	SILO PRETO BPL ESPECIAL 4 X 100 27 KG	1
23458	SILO PRETO BPL ESPECIAL 6 X 100 40 KG	1
23923	SILO PRETO BPL ESPECIAL 8 X 100 54 KG	1



Agrolord: inovando em toda linha de Plasticultura. Não fique de fora!



greenwrap

Stretch para feno

Filme plástico produzido com alta performance, 12 meses de garantia para Feno pré-secado.

VANTAGENS

Auxilia na proteção e conservação do material ensilado;
Mantém a qualidade nutritiva;
Alto rendimento.



Mulching para cobertura de canteiros e de solo

Disponível nas versões:

MPP - mulching Preto & Prata

MPB - mulching Preto & Branco

Ideal para culturas de morango, café, banana, alface e diversas outras.



VANTAGENS

Mantém a umidade do solo, economiza água e energia
Melhoria da qualidade e produtividade.
Redução do custo de produção.



agrolord[®]
PREMIUM

Lonas para silagem e insumos

VANTAGENS

Aditivação UV - proteção contra raios solares
Alta resistência mecânica e durabilidade
Adequada ao manuseio no momento de ensilar.

Disponível em três versões:

- Silo preto super pró - preto
- Silo preto e branco super - dupla face
- Silo preto e branco plus - dupla face



agrolord[®]
FILMES AGRÍCOLAS

Sigam nossas redes sociais:

 @agrolordoficial

 @agrolordoficial

 Agrolord

www.agrolord.com

arteplas

cordas e fibras

Tecnologia a favor da natureza





BASSO PANCOTTE

Produtos para Agropecuária

Ferragens



Código	Descrição	Cx.
4016	BARBANTE 100% ALG.SALAME 50G C/10 UNID.	25



Código	Descrição	Cx.
728	BARBANTE RAMI ENCR 1KG (2 X 500G)	36



Código	Descrição	Cx.
5313	BARBANTE RAMI.ELEFANTE 50G C/10 UNI. ENCRERADO	1



Código	Descrição	Cx.
33408	CORDA MAZZAF 10MM MULTICOLOR 190M	1
33409	CORDA MAZZAF 12MM MULTICOLOR 140M	1
33403	CORDA MAZZAF 3MM MULTICOLOR 625M	6
33405	CORDA MAZZAF 5MM MULTICOLOR 250M	1
33406	CORDA MAZZAF 6MM MULTICOLOR 165M	1
33407	CORDA MAZZAF 8MM MULTICOLOR 258M	1



Código	Descrição	Cx.
24961	CORDA RIOMAR TROPICAL 3 MM 625 M POLIP.	1
24962	CORDA RIOMAR TROPICAL 4 MM 400M POLIP.	1
24963	CORDA RIOMAR TROPICAL 5 MM 250 M POLIP.	1
24960	CORDA RIOMAR TROPICAL 6 MM 165 M POLIP.	1
24964	CORDA RIOMAR TROPICAL 8 MM 258 M POLIP.	1
24965	CORDA RIOMAR TROPICAL 10 MM 190 M POLIP.	1
24966	CORDA RIOMAR TROPICAL 12 MM 140 M POLIP.	1



Código	Descrição	Cx.
23819	CORDAO CADEIRA AZUL 1 KG	1
2364	CORDAO CADEIRA BRANCO 1 KG	20
23818	CORDAO CADEIRA ROXO (LILAS) 1 KG	1
23817	CORDAO CADEIRA VERDE 1 KG	1
23820	CORDAO CADEIRA VERMELHO 1 KG	1



Código	Descrição	Cx.
12154	CORDA PP MEADA 10MM X 20 M COLORIDA	9
12155	CORDA PP MEADA 10MM X 30 M COLORIDA	6
12150	CORDA PP MEADA 6MM X 20 M COLORIDA	30
12151	CORDA PP MEADA 6MM X 30 M COLORIDA	18
12152	CORDA PP MEADA 8MM X 20 M COLORIDA	16
12153	CORDA PP MEADA 8MM X 30 M COLORIDA	9



Código	Descrição	Cx.
12147	CORDA AQUARELA 10MM COLORIDA PP 190MT	1
12148	CORDA AQUARELA 12MM COLORIDA PP 140MT	1
12149	CORDA AQUARELA 14MM COLORIDA PP 110MT	1
12143	CORDA AQUARELA 3MM COLORIDA PP 625MT	1
12142	CORDA AQUARELA 4MM COLORIDA PP 360MT	1
12144	CORDA AQUARELA 5MM COLORIDA PP 250MT	1
12145	CORDA AQUARELA 6MM COLORIDA PP 165MT	1
12146	CORDA AQUARELA 8MM COLORIDA PP 258MT	1



Código	Descrição	Cx.
1312	CORDA ARTEPL MONOFI 4 MM ROLO 220MT	2
36224	CORDA ARTEPL MONOFI 5 MM ROLO 190MT	1
967	CORDA ARTEPL MONOFI 6 MM ROLO 150 MT	1
968	CORDA ARTEPL MONOFI 8 MM ROLO 317MT	1
969	CORDA ARTEPL MONOFI 10 MM ROLO 219 MT	1
970	CORDA ARTEPL MONOFI 12 MM ROLO 154 MT	1



Código	Descrição	Cx.
3113	CORDA ARTEPLAS MONOFI 14 MM ROLO	1



Código	Descrição	Cx.
10457	CORDA ECO ROPE 10MM COLORIDA PET 165MT	1
10458	CORDA ECO ROPE 12MM COLORIDA PET 105MT	1
10459	CORDA ECO ROPE 14MM COLORIDA PET 68MT	1
10452	CORDA ECO ROPE 3MM COLORIDA PET 400MT	2
10453	CORDA ECO ROPE 4MM COLORIDA PET 220MT	2
10454	CORDA ECO ROPE 5MM COLORIDA PET 190MT	2
10455	CORDA ECO ROPE 6MM COLORIDA PET 150MT	2
10456	CORDA ECO ROPE 8MM COLORIDA PET 240MT	1



Código	Descrição	Cx.
1731	CORDA RIOMAR MONOF PE 4 MM 4 KG AZUL	1
1732	CORDA RIOMAR MONOF PE 6 MM 5 KG AZUL	6
1734	CORDA RIOMAR MONOF PE 10 MM 15 KG AZUL	4



BASSO PANCOTTE

Produtos para Agropecuária

Ferragens



Código	Descrição	Cx.
1768	CORDA RIOMAR MONOFI CHATA 25 MM 15 KG	1



Código	Descrição	Cx.
975	CORDA ARTEPL MULTIF 4 MM BRANCA 220 MT	1
1019	CORDA ARTEPL MULTIF 5 MM BRANCA 190 MT	4
1066	CORDA ARTEPL MULTIF 6 MM ROLO 150 MT	1
9660	CORDA ARTEPL MULTIF 8 MM BRANCA 240 MT	1
965	CORDA ARTEPL MULTIF 10 MM BRANCA 165 MT	4
1067	CORDA ARTEPL MULTIF 12 MM ROLO 105 MT	4
3115	CORDA ARTEPL MULTIF 14 MM BRANCA 136 MT	1
24815	CORDA ARTEPL MULTIF 16 MM BRANCA 94 MT	1



Código	Descrição	Cx.
31905	CORDA MAZZAF POLIP 1,5MM 1 KG ROLO	25
31908	CORDA MAZZAF POLIP 3,0MM 1 KG ROLO	5
31912	CORDA MAZZAF POLIP 6,0MM 110 mt ROLO	1



Código	Descrição	Cx.
4745	CORDA MAZZAF POLIP 8MM 360 mt	1
4746	CORDA MAZZAF POLIP 10MM ROLO 270 mt	1
4747	CORDA MAZZAF POLIP 12MM 180 mt	1
4748	CORDA MAZZAF POLIP 14MM 140 mt	1
4749	CORDA MAZZAF POLIP 16MM 115 mt	1
4750	CORDA MAZZAF POLIP 18MM 90 mt	1



Código	Descrição	Cx.
27252	CORDA BRAN MULTIF 2 MM RIO 408 MT ROLO	15
4304	CORDA BRAN MULTIF 2,5 MM RIO 372 MT ROLO	30
1723	CORDA BRAN MULTIF 3 MM RIO 277MT ROLO	25
27253	CORDA BRAN MULTIF 4 MM RIO 400MT ROLO	1
2749	CORDA BRAN MULTIF 5 MM RIO 356 MT ROLO	40
1726	CORDA BRAN MULTIF 6 MM RIO 191 MT ROLO	1



Código	Descrição	Cx.
1727	CORDA RIOMAR MULTIF 8 MM ROLO 15 KG	1
1728	CORDA RIOMAR MULTIF 10 MM ROLO 15 KG	1
1729	CORDA RIOMAR MULTIF 12 MM ROLO 15 KG	1
1865	CORDA RIOMAR MULTIF 14 MM ROLO 15 KG	1
1866	CORDA RIOMAR MULTIF 16 MM ROLO 15KG	1
2748	CORDA RIOMAR MULTIF 18 MM ROLO 15 KG	1



Código	Descrição	Cx.
36671	CORDA RIOMAR MULTIF 22 MM CHATA 95 MT ROLO	1



Código	Descrição	Cx.
2353	CORDA RIOMAR POLIES 4 MM PET ROLO 5 KG	1
2308	CORDA RIOMAR POLIES 6 MM PET ROLO 6 KG	1
2309	CORDA RIOMAR POLIES 8 MM PET ROLO 15 KG	1
2310	CORDA RIOMAR POLIES 10 MM PET ROLO 15 KG	1
2311	CORDA RIOMAR POLIES 12 MM PET ROLO 15 KG	1
2312	CORDA RIOMAR POLIES 14MM PET ROLO 15 KG	1
2354	CORDA RIOMAR POLIES 16MM PET ROLO 15 KG	1



Código	Descrição	Cx.
1418	CORDA SISAL 6 MM ROLO 200MT	1
1419	CORDA SISAL 8 MM ROLO 220MT	1
1420	CORDA SISAL 10 MM ROLO 220MT	1
1421	CORDA SISAL 12 MM ROLO 220MT	1
4175	CORDA SISAL 14 MM ROLO 220MT	1



Código	Descrição	Cx.
4488	ARGOLA CABO DE ACO 7/8" 3 TONEL CINFER	5



Código	Descrição	Cx.
4525	GANCHO P/ CABO DE ACO 1" 3 TONEL. CINFER	5



Código	Descrição	Cx.
3846	EMENDA " S " 3 MM C/10 UNID.	1
3847	EMENDA " S " 4 MM C/10 UNID	1



BASSO PANCOTTE

Produtos para Agropecuária

Ferragens



Código	Descrição	Cx.
1921	CORRENTE ELO LONGO POL. 45 C 12,5 KG	1
5038	CORRENTE ELO LONGO POL. 50 C 12,5 KG	1
22899	CORRENTE ELO LONGO POL. 60 C 25 KG	1



Código	Descrição	Cx.
1923	CORRENTE ELO SOL. POL. 30 B 12,5 KG	1
2904	CORRENTE ELO SOL. POL. 35 B 12,5 KG	1
1927	CORRENTE ELO SOL. POL. 40 B 12,5 KG	1
5039	CORRENTE ELO SOL. POL. 45 B 12,5 KG	1
1928	CORRENTE ELO SOL. POL. 50 B 12,5 KG	1
3139	CORRENTE ELO SOL. POL. 55 B 12,5 KG	1

Código	Descrição	Cx.
3140	CORRENTE ELO SOL. POL. 60 B 25 KG	1
1924	CORRENTE ELO SOL. POL. 65 B 25 KG	1
1925	CORRENTE ELO SOL. POL. 80 B 25 KG	1
3141	CORRENTE ELO SOL. POL. 90 B 25 KG	1
1926	CORRENTE ELO SOL. POL. 95 B 25 KG	1
2176	CORRENTE ELO SOL. POL. 110 B 25 KG	1
23285	CORRENTE ELO SOL. POL. 125 B SC 50 KG	1
32920	CORRENTE ELO SOL. POL. 145 B SC 25 KG	1
3144	CORRENTE ELO SOL. POL. 155 B SC 50 KG	1



Código	Descrição	Cx.
10794	CORRENTE ELO SOL. ZIN. 110 B 25 KG	1
2143	CORRENTE ELO SOL. ZIN. 24 B 12,5 KG	1
1856	CORRENTE ELO SOL. ZIN. 30 B 12,5 KG	1
1850	CORRENTE ELO SOL. ZIN. 40 B 12,5 KG	1
5323	CORRENTE ELO SOL. ZIN. 45 B 12,5 KG	1
1851	CORRENTE ELO SOL. ZIN. 50 B 12,5 KG	1
4247	CORRENTE ELO SOL. ZIN. 60 B 25 KG	1
1857	CORRENTE ELO SOL. ZIN. 65 B 25 KG	1
2792	CORRENTE ELO SOL. ZIN. 70 B 25 KG	1
1858	CORRENTE ELO SOL. ZIN. 80 B 25 KG	1
5894	CORRENTE ELO SOL. ZIN. 90 B 25 KG	1



Código	Descrição	Cx.
2296	CORRENTE VITOR 3 GALV. SC 20 M	10
2787	CORRENTE VITOR 5 GALV. SC 20 M	10
2301	CORRENTE VITOR 7 GALV. SC 20 M	1



Código	Descrição	Cx.
25440	FIO TORCIDO NYLON 210/006 200 G BCO	20
24881	FIO TORCIDO NYLON 210/012 200 G BCO	10
24843	FIO TORCIDO NYLON 210/024 200G BCO	20



Código	Descrição	Cx.
11740	FIO F10 POLIPR. T3 P/ FENO ROLO C/ 2.000 MT	6



Código	Descrição	Cx.
1589	FIO INDUCOR CHICOTE 360M POLIP. UNID CHICOTE	30



Código	Descrição	Cx.
1591	FIO INDUCOR FITA LARGA KG F10 ROLO	30



Código	Descrição	Cx.
810	FIO INDUCOR TORCIDO KG F-10 ROLO	30



Código	Descrição	Cx.
27723	FITILHO M-30 BRANCO INDUCOR	30



Código	Descrição	Cx.
26123	FIO MAQUINA COST. SACO 1KG/4X250G 100% POLISTER	1



BASSO PANCOTTE

Produtos para Agropecuária

Ferragens



Código	Descrição	Cx.
4176	FIO SISAL 300/1 500G ROLO 2MM	1
2225	FIO SISAL 500/1 500G ROLO 1MM	1



Código	Descrição	Cx.
4168	FIO SISAL FENO 3 MM C/2 BOBINAS (2X9,00 KG)	1



Código	Descrição	Cx.
4165	FITILHO TOMATE OURO NO 8 (NOVELO)	1



Código	Descrição	Cx.
23085	FITILHO M-30 COR ESCURA (RECICLADO) 1 KG	15



Código	Descrição	Cx.
25818	PENEIRA ARO MAD AREIA 55	6
25819	PENEIRA ARO MAD AREIA 60	6



Código	Descrição	Cx.
37354	PENEIRA ARO PLASTICO AGROBR AREIA 55	10



Código	Descrição	Cx.
25817	PENEIRA ARO MAD CAL 55	6



Código	Descrição	Cx.
25815	PENEIRA ARO MAD FUBA 30	6
25816	PENEIRA ARO MAD FUBA 50	6



Código	Descrição	Cx.
25204	PENEIRA ARO MAD. ARROZ 55	1



Código	Descrição	Cx.
25209	PENEIRA ARO MAD. CAFE 60	1



Código	Descrição	Cx.
25206	PENEIRA ARO MAD. FEIJAO 55	6
25207	PENEIRA ARO MAD. FEIJAO 60	6



Código	Descrição	Cx.
37355	PENEIRA ARO PLASTICO AGROBR ARROZ 55	10
37356	PENEIRA ARO PLASTICO AGROBR FEIJAO 55	10
37357	PENEIRA ARO PLASTICO AGROBR FUBA 30	20



BASSO PANCOTTE

Produtos para Agropecuária

Ferragens



Código	Descrição	Cx.
25210	TELA P/PENEIRA MALHA 6 MM X 24 X 1X10M	1



Código	Descrição	Cx.
2351	GRAMPO 1 X 9 GALVANIZADO CX 20 KG	1



Código	Descrição	Cx.
2352	GRAMPO 1 X 9 POLIDO CX 20 KG	1



Código	Descrição	Cx.
2335	PREGO 12 X 12 CX 20 KG	1
2337	PREGO 13 X 15 CX 20 KG	1
1319	PREGO 15 X 15 CX 20 KG	1
2339	PREGO 15 X 18 CX 20 KG	1
23707	PREGO 15 X 21 CX 20 KG	1
2724	PREGO 16 X 21 CX 20 KG	1
2340	PREGO 16 X 24 CX 20 KG	1
4029	PREGO 16 X 27 CX 20 KG	1
2341	PREGO 17 X 21 CX 20 KG	1
4028	PREGO 17 X 24 CX 20 KG	1
2342	PREGO 17 X 27 CX 20 KG	1

Código	Descrição	Cx.
3353	PREGO 17 X 27 CX 20 KG CABECA DUPLA	1
2343	PREGO 18 X 24 CX 20 KG	1
2490	PREGO 18 X 27 CX 20 KG	1
2344	PREGO 18 X 30 CX 20 KG	1
2928	PREGO 18 X 36 CX 20 KG	1
2772	PREGO 19 X 30 CX 20 KG	1
2345	PREGO 19 X 36 CX 20 KG	1
2346	PREGO 19 X 39 CX 20 KG	1
27262	PREGO 20 X 30 CX 20 KG	1
2347	PREGO 21 X 45 CX 20 KG	1
23043	PREGO 21 X 48 CX 20 KG	1
2403	PREGO 22 X 42 CX 20 KG	1
2348	PREGO 22 X 48 CX 20 KG	1
2349	PREGO 22 X 54 CX 20 KG	1
2350	PREGO 24 X 60 CX 20 KG	1
1349	PREGO 25 X 72 CX 20 KG	1
26441	PREGO 26 X 84 CX 20 KG	1



Código	Descrição	Cx.
28471	PREGO TELHEIRO 18X27 (20 X 500 G) GERDAU	1



Código	Descrição	Cx.
11045	ELETRODO MAGMA 6013 CAIXA 3,25MM 5 KG	4
11044	ELETRODO MAGMA 6013 CAIXA 2,50MM 5 KG	4



Código	Descrição	Cx.
13439	DISCO C/DENTES REMOVIVEIS P/ ROCADEIRA 230mm AFIAÇO	1



Código	Descrição	Cx.
13440	LAMINA P/ ROCADEIRA 3 PONTA 240 X 210 x 1,5 FURO 25 MM	1



Código	Descrição	Cx.
13438	LAMINA P/ ROÇAD. 350 X 82 X 1,75 FURO 20MM	1
13197	LAMINA P/ ROÇAD. 350 X 82 X 1,75 FURO 25 MM	1

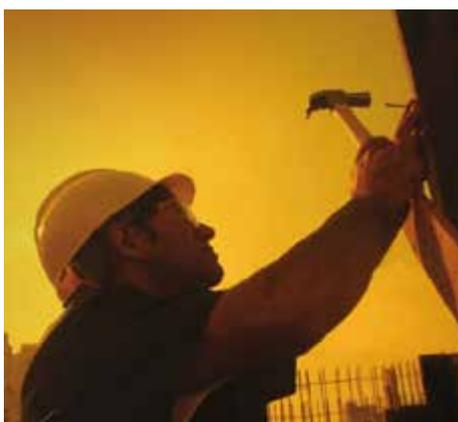

Código	Descrição	Cx.
13437	LAMINA P/ ROÇAD. 350 X 82 X 2,0 FURO 20 MM	1
13196	LAMINA P/ ROÇAD. 350 X 82 X 2,0 FURO 25 MM	1

UTILIDADE E DESEMPENHO A SERVIÇO DA SUA NECESSIDADE.



TRAMONTINA

O prazer de fazer bonito.



BASSO PANCOTTE

Produtos para Agropecuária

Jardinagem



Código	Descrição	Cx.
31892	GRASSFIO 1.6MM 30MT (CLIPLINE)	36
31893	GRASSFIO 1.8MM 30MT (CLIPLINE)	1
31894	GRASSFIO 2.0MM 30MT (CLIPLINE)	24
31895	GRASSFIO 2.4MM 30MT (CLIPLINE)	1
31903	GRASSFIO 2.6MM 30MT (CLIPLINE)	12
31896	GRASSFIO 3.0MM 25MT (CLIPLINE)	24



Código	Descrição	Cx.
31897	GRASSFIO 1.6MM 1 KG CARRETEL (437 MT P/KG)	12
31898	GRASSFIO 1.8MM 1 KG CARRETEL (345 MT P/KG)	12
31899	GRASSFIO 2.0MM 1 KG CARRETEL (279 MT P/KG)	1
31900	GRASSFIO 2.4MM 1 KG CARRETEL (194 MT P/KG)	12
31901	GRASSFIO 2.6MM 1 KG CARRETEL (165 MT P/KG)	1
31902	GRASSFIO 3.0MM 1 KG CARRETEL (124 MT P/KG)	1



Código	Descrição	Cx.
32903	GRASSFIO 1.8MM 1 KG FIO QUADRADO	12
32901	GRASSFIO 2.4MM 1 KG FIO QUADRADO	12
34782	GRASSFIO 2.6MM 1 KG FIO QUADRADO	12
32902	GRASSFIO 3.0MM 1 KG FIO QUADRADO	1



Código	Descrição	Cx.
11413	APARADOR GRAMA 110V 1000W TRAM	1
819	APARADOR GRAMA 220V 1000W TRAM	1



Código	Descrição	Cx.
33866	CORTADOR GRAMA TRAM. 110V 1 CV 79649/110	1



Código	Descrição	Cx.
820	CORTADOR GRAMA C/REC TRAM. 220V 1CV	1



Código	Descrição	Cx.
36634	CARRETEL P/APARADOR TRAM. 78799/463	12



Código	Descrição	Cx.
36633	TAMPA CARRET. APAR. TRAM. 78799/716	12



Código	Descrição	Cx.
1154	TRITURADOR TRAM FORAG 2HP BIVOLT	1



Código	Descrição	Cx.
24424	ENXO PANDOLFO GOIVO C/C REF 191	6



Código	Descrição	Cx.
6115	ANCINHO 12 D. ACO ESP S/C DENTE COMPRIDO	1



Código	Descrição	Cx.
5246	ANCINHO LEVE 12 DENTES C/C PARABONI	6
24621	ANCINHO LEVE 14 DENTES C/C PARABONI	6



BASSO PANCOTTE

Produtos para Agropecuária

Jardinagem

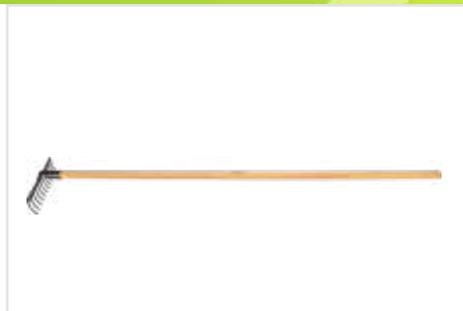

Código	Descrição	Cx.
5318	ANCINHO CURVO C/C 77101/624 TRAMONTINA	1
1942	ANCINHO CURVO S/C 77101/124 TRAMONTINA	12



Código	Descrição	Cx.
4027	VASSOU. GRAMA 22 DENT C/C PCT C/6 LINAN	1



Código	Descrição	Cx.
12695	RASTEL GRAMA 21 DENT C/C PCT C/6 LINAN	1



Código	Descrição	Cx.
29598	VASSOU. TRAM PLAST. 18D C/C 120CM	1
29599	VASSOU. TRAM PLAST. 22D C/C 120CM	1

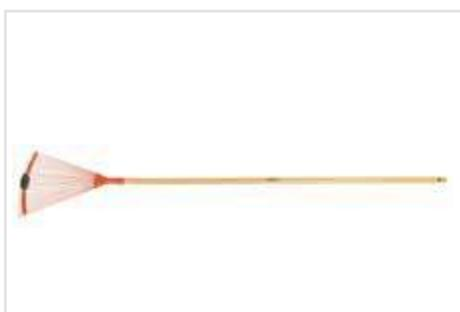

Código	Descrição	Cx.
3480	VASSOU. TRAM REG. C/C 77831/721 (ARAME)	1

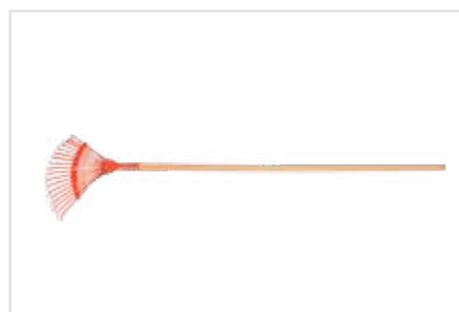

Código	Descrição	Cx.
31755	VASSOU. TRAM MET 18D C/C 120CM 77836/681	1

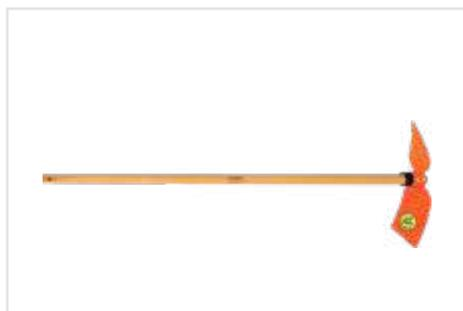

Código	Descrição	Cx.
6339	SACHO 1 PONTA C/C 77800/501 TRAMONT	1
3468	SACHO 2 PONTAS C/C 77802/501 TRAMON	1
1947	SACHO 2 PONTAS S/C 77802/001 TRAMON	12



Código	Descrição	Cx.
1498	ANCINHO PARA JARDIM 77909/001 TRAMO	12



Código	Descrição	Cx.
1499	ARRANCADOR INCO 77910/001 TRAM	12



Código	Descrição	Cx.
1497	PAZINHA ESTREITA C/C 77908/001 TRAM	12



Código	Descrição	Cx.
1496	PAZINHA LARGA C/C 77907/001 TRAMONT	12



Código	Descrição	Cx.
22971	CONJ PARA JARDIM 78102/801 TRAM.	1



BASSO PANCOTTE

Produtos para Agropecuária

Jardinagem



Código	Descrição	Cx.
1495	ESCARDILHO C/C 77903/001 TRAMONTINA	12



Código	Descrição	Cx.
1494	GARFO P/AFOFAR TERRA 77915/001 TRAM	12

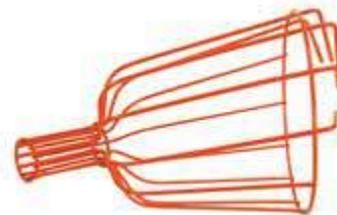

Código	Descrição	Cx.
3352	COLHEDOR FRUTAS 77819/151 TRAMON	6
1493	COLHEDOR FRUTAS 77819/201 TRAMON	6



Código	Descrição	Cx.
24145	TESOURA TRAM FRUTAS 78310/101	1



Código	Descrição	Cx.
1883	TESOURA P/ FRUTAS 8 'BASPAN 33031546B	60



Código	Descrição	Cx.
5485	TESOURA TRAM CERCA VIVA 78330/125	1



Código	Descrição	Cx.
1050	TESOURA TRAM PODA CABO COMP 78360/505	8



Código	Descrição	Cx.
1876	TESOURA PODA CABO COMP BASPAN	10



Código	Descrição	Cx.
4534	TESOURA TRAM PODA PROFI.78304/511	1



Código	Descrição	Cx.
2051	SERROTE PODADOR C/GUILHOTINA12 S/C 78380/701 TRAM	2



Código	Descrição	Cx.
4535	SERROTE TRAM C/BAINHA 78374/401 PODA	6



Código	Descrição	Cx.
1476	TESOURA TRAM PODA 78300/001	110



BASSO PANCOTTE

Produtos para Agropecuária

Jardinagem



Código	Descrição	Cx.
1854	TESOURA DE PODA 8" BASPAN	60



Código	Descrição	Cx.
1855	TESOURA DE PODA 8" BASPAN C/ MADEIRA 33040024-A	60



Código	Descrição	Cx.
29004	TESOURA PODA JAPONESA 8" BERG REF.21.241.08	60



Código	Descrição	Cx.
53	SERROTE DE PODA FIXO BASPAN C/BAINHA " 10 " BP 8007	1



Código	Descrição	Cx.
2648	SERROTE NICHELSON 12" PODA	6



Código	Descrição	Cx.
29597	SERROTE DE PODA 12" 43290/012 TRAM	6



Código	Descrição	Cx.
1383	SERROTE TRAM PODA 12" 43291/012	6



Código	Descrição	Cx.
29247	SERROTE PODA C/GANCHO REF 516 BASPAN	12



Código	Descrição	Cx.
29245	SERROTE PODA CURVO REF 510 BASPAN	12
29246	SERROTE PODA CURVO REF 512 BASPAN	12
29248	SERROTE PODA CURVO REF 518 BASPAN	12



Código	Descrição	Cx.
33950	LAMINA P/ SER PODA DOBRÁVEL BASPAN "10"	1



Código	Descrição	Cx.
6535	LAMINA P/SERROTE TRAM. 78399/005	6
6536	LAMINA P/SERROTE TRAM. 78399/006	6



Código	Descrição	Cx.
3038	MOLA PUFFER TES. 95.23560 C/10 UNID. 52 MM BERG	10



BASSO PANCOTTE

Produtos para Agropecuária

Jardinagem



Código	Descrição	Cx.
8675	MOLA P/ TESOURA DE PODA 8" BASPAN C/ MAD. 33040024-A C/2UND	1



Código	Descrição	Cx.
6338	MOLA P/TES.PODA/003 C/2 UNID. TRAM.	12
10052	MOLA P/TES.PODA PROF C/2 UNID.TRAM	6



Código	Descrição	Cx.
11020	SEPARADOR DE GRAMA CAIXA C/ 50 MT	1



Código	Descrição	Cx.
29607	REGADOR 10 L BASPAN	6
29608	REGADOR 5 L BASPAN	6



Código	Descrição	Cx.
27165	REGADOR 5 L PLAST. METASUL	8



Código	Descrição	Cx.
29611	CRIVO REGADOR 10 L BASPAN	200



Código	Descrição	Cx.
27166	CRIVO REGADOR 10 L METASUL	24



Código	Descrição	Cx.
34530	IRRIGADOR GIR. BASE ESQUI HERC ENCART.	48



Código	Descrição	Cx.
6458	ASPERSOR SERVI 50 CM	1



Código	Descrição	Cx.
34353	IRRIGADOR GIRATORIO ESPIGA HERC ENCART.	60



Código	Descrição	Cx.
9674	DISPERSOR DE AGUA PEQ.C/HASTE PLASTICO	12



Código	Descrição	Cx.
34354	ESGUICHO PISTOLA HERC ENCART.	1



BASSO PANCOTTE

Produtos para Agropecuária

Jardinagem



Código	Descrição	Cx.
23146	ESGUICHO ZINCADO P/ MANGUEIRA	1



Código	Descrição	Cx.
3462	ADAPTADOR MANG JARD 78502/750 TRAMONTINA	75



Código	Descrição	Cx.
1159	DUCHA 10 FUNCOES TRAMONTINA 78520/500	6



Código	Descrição	Cx.
3465	ENGATE RAPIDO P/MANG. 78506/750 TRA	40



Código	Descrição	Cx.
1158	ESGUICHO PISTOLA 78535/400 TRAMONTINA	6



Código	Descrição	Cx.
1161	ESGUICHO PISTOLA REFORCADO 78520/501 TRAMONTINA	6



Código	Descrição	Cx.
7026	ESGUICHO REGULAVEL (DUCHA) 78521/400 TRAMONTINA	6

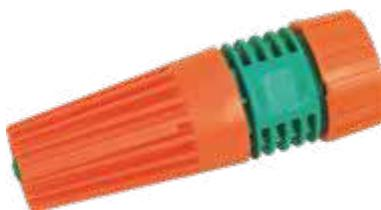

Código	Descrição	Cx.
1157	ESGUICHO ROSQUEADO 78514/750 TRAMONTINA	30



Código	Descrição	Cx.
3467	ESGUICHO TRAMONTINA 78515/750	25



Código	Descrição	Cx.
1160	IRRIGADOR TRAMONTINA 78523/500	6



Código	Descrição	Cx.
24599	LIGACAO REPARAD. MANG. TRAM 78510/750	55



Código	Descrição	Cx.
631	SUPORTE P/ MANGUEIRA 78592/000 TRAM	12



BASSO PANCOTTE

Produtos para Agropecuária

Jardinagem



Código	Descrição	Cx.
3579	MANG JARD TRANCADA 10 M C/ESG	12
3580	MANG JARD TRANCADA 15 M C/ESG	1
4743	MANG JARD TRANCADA 30 M C/ESG	1



Código	Descrição	Cx.
1533	MANG JARD LISA 10 M C/ESG	1
1532	MANG JARD LISA 15 M C/ESG	10
1534	MANG JARD LISA 20m C/ESG	1
1536	MANG JARD LISA 30 M C/ESG	10



Código	Descrição	Cx.
9073	MANG TRANCADA 3/8X 3.2MM MULTIUSO 50 M	1



Código	Descrição	Cx.
28671	MANG JARD EXTRA FLEX 10 M C/ESG 1/2X2 MM	1
28672	MANG JARD EXTRA FLEX 15 M C/ESG 1/2X2 MM	1
28673	MANG JARD EXTRA FLEX 20 M C/ESG 1/2X2 MM	1
28674	MANG JARD EXTRA FLEX 25 M C/ESG 1/2X2 MM	1
28675	MANG JARD EXTRA FLEX 30 M C/ESG 1/2X2 MM	1
28676	MANG JARD EXTRA FLEX 50 M C/ESG 1/2X2 MM	1
28677	MANG JARD EXTRA FLEX.150 M S/ESG 1/2X2 MM	1



Código	Descrição	Cx.
6333	MANG JARD TRAM TRANC.10M	1
6334	MANG JARD TRAM TRANC.15M	12
6335	MANG JARD TRAM TRANC.20M	1
6336	MANG JARD TRAM TRANC.25M	1
24326	MANG JARD TRAM TRANC.30M	1
23016	MANG JARD TRAM.TRANC 200M	1



Código	Descrição	Cx.
33743	MANG JARD. TRAM. 200M 79210/521 LARAN FLEX.	1



Código	Descrição	Cx.
9164	TORNEIRA JARDIM 1/2 e 3/4 "HERC 1128	1



Código	Descrição	Cx.
2777	TORNEIRA JARDIM 1/2 "LUCONI C/12UN.PACOTE	50
1523	TORNEIRA JARDIM 3/4 "LUCONI C/12UN.PACOTE	1



Código	Descrição	Cx.
36361	EXPOSITOR MANGUEIRA HARPLA	1



Código	Descrição	Cx.
4740	ENROLADOR DE MANGUEIRA 78595/000 TR	1



Código	Descrição	Cx.
25851	EXPOSITOR P/MANG. TRAM 79894/034.	1



BASSO PANCOTTE

Produtos para Agropecuária

Camping



Código	Descrição	Cx.
22567	ABRACAD. R.S/F 1"1/2X2" C/25 UNID.	1
22566	ABRACAD. R.S/F 1"X1"1/2 C/25 UNID.	12
22564	ABRACAD. R.S/F 1/2X3/4 GAS C/25 UNID.	48
22569	ABRACAD. R.S/F 1/2X7/8 C/25 UNID.	1
22563	ABRACAD. R.S/F 5/16X1/2 C/25 UNID.	1
22565	ABRACAD. R.S/F 5/8X1"1/16 C/25 UNID.	48



Código	Descrição	Cx.
11840	CARREGADOR BATERIA 10 AH FAZENDEIRO	1



Código	Descrição	Cx.
25731	CARREGADOR BATERIA 10 AH CB100 ZEBU	6
25729	CARREGADOR BATERIA 20 AH CB200 ZEBU	4



Código	Descrição	Cx.
5361	COLETE SALVA VIDAS MOD. 15	1
4607	COLETE SALVA VIDAS MOD. 20	1
5248	COLETE SALVA VIDAS MOD. 30	1
4608	COLETE SALVA VIDAS MOD. 50	1
6320	COLETE SALVA VIDAS MOD. 60	1
4609	COLETE SALVA VIDAS MOD. 75	1
4610	COLETE SALVA VIDAS MOD. 90	1
6321	COLETE SALVA VIDAS MOD. 105	1
4611	COLETE SALVA VIDAS MOD. 110	1
4612	COLETE SALVA VIDAS MOD. 120	1
26872	COLETE SALVA VIDAS MOD. 140	1



Código	Descrição	Cx.
6530	CAULIN FOGAREIRO C/12 UN (CHUVEIRINHO)	1



Código	Descrição	Cx.
23235	FOG AP 2 QUEI. C/4 CAUL.(CHAPA LEVE) ACF-0107LL	1



Código	Descrição	Cx.
5308	FOG AP 2 QUEI.C/4 CAUL.(CANTONEIRA) ACF-0107	1



Código	Descrição	Cx.
5305	FOG AP SIMPLES ACF-0103	1



Código	Descrição	Cx.
23667	FOG QUADRADO 1 QUEI. C/4 CAUL.CHAPA LEVE ACF-0114	1



Código	Descrição	Cx.
33494	FOG. RED. 12 CAU 2 REG. C/ PES R 0119 ARACEBA	1

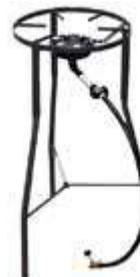

Código	Descrição	Cx.
26925	FOG. RED. AP 1 Q.. C/6 CAUL. ALTO 80CM ACF-0104PA	1



BASSO PANCOTTE

Produtos para Agropecuária

Camping



Código	Descrição	Cx.
5307	FOG. REDONDO AP 1 QUEIM. C/6 CAULIM ACF-0104	1



Código	Descrição	Cx.
37487	FOG. RED. ZINC 12 CAU 2 REG. ALTO C/2 UND R 110.1 PAPAN.	1



Código	Descrição	Cx.
29616	FOG. RED. ZINC 12 CAU 2 REG. DUPLO C/2 UND R 029 PAPAN.	1



Código	Descrição	Cx.
29614	FOG. RED. ZINC C/4 CAUL REF C/2 UND	1
37486	FOG. RED. ZINC C/6 CAUL C/2 UND ALTO REF	1
29615	FOG. RED. ZINC C/6 CAUL C/2 UND REF 025	1



Código	Descrição	Cx.
34328	LANTERNA BASPAN ST-SG7307-12 LED PILHA	100
34329	LANTERNA BASPAN ST-SG7315-16 LED PILHA	100



Código	Descrição	Cx.
1892	CHAVEIRO C/ LED BASPAN 65110013A	200



Código	Descrição	Cx.
1893	LANTERNA BASPAN 9 LED 64101402A PILHA	200



Código	Descrição	Cx.
255	LANTERNA BASPAN CELEBRIM BP 8035C	24



Código	Descrição	Cx.
266	LANTERNA BASPAN RECAR. 12 LED BP 4024 L	30
252	LANTERNA BASPAN RECAR. BP 9135	10



Código	Descrição	Cx.
11693	LANTERNA BASPAN RECAR. BIVOLT 1 LED BP 4311	1



Código	Descrição	Cx.
264	LANTERNA BASPAN RECAR. BP 5031	105



Código	Descrição	Cx.
25541	GARRAFA TERMICA 5 L TERMOLAR	6



BASSO PANCOTTE

Produtos para Agropecuária

Camping



Código	Descrição	Cx.
8822	GARRAFA TERMICA 1L 7800CSF3 CHIMARRITA D ACAO	6



Código	Descrição	Cx.
8809	GARRAFA TERMICA INOX 1,8L 9750 LUMINA	6



Código	Descrição	Cx.
8812	GARRAFA TERMICA INOX 1L 9731 LUMINA	6



Código	Descrição	Cx.
9903	GARRAFA TERMICA 1,8L 8709VRO MAGIC PUMP	6
8821	GARRAFA TERMICA 1,8L 8799GAD MAGIC PUMP	6
8813	GARRAFA TERMICA 1,8L 8709BRA1 MAGIC PUMP	6
8818	GARRAFA TERMICA 1,8L 8709SF1 MAGIC PUMP	6
8814	GARRAFA TERMICA 1L 8700BRA MAGIC PUMP	6
8817	GARRAFA TERMICA 1L 8790GAU MAGIC PUMP	6



Código	Descrição	Cx.
25748	MOLINETE POWER 3000 3 ROLAM.	1



Código	Descrição	Cx.
24584	MOLINETE POWER 5000 3 ROLAM.	1



Código	Descrição	Cx.
34046	MOLINETE BASPAN SUPRA BP-S 30 6+1BB	20
34047	MOLINETE BASPAN SUPRA BP-S 40 6+1BB	20



Código	Descrição	Cx.
37934	SUPORE PARA VARA DE PESCA	1



Código	Descrição	Cx.
24582	MOLINETE JIMMY 100 1 ROLAM.	1



Código	Descrição	Cx.
34042	MOLINETE BASPAN CLASSIC BP-C 40 3BB	20
34043	MOLINETE BASPAN CLASSIC BP-C 50 5BB	20
34044	MOLINETE BASPAN CLASSIC BP-C 60 3BB	20



Código	Descrição	Cx.
34045	MOLINETE BASPAN PRIME BP-P 40 3+1BB	20



Código	Descrição	Cx.
34734	VARA PESCA MACICA 2,10 (2 PARTES)	1
34520	VARA PESCA MACICA 1,35 (2 PARTES)	1
34521	VARA PESCA MACICA 1,50 (2 PARTES)	1
34522	VARA PESCA MACICA 1,65 (2 PARTES)	1
34523	VARA PESCA MACICA 1,80 (2 PARTES)	1



BASSO PANCOTTE

Produtos para Agropecuária

Camping



Código	Descrição	Cx.
34993	VARA TELESCOPIA 3 MT	1
34994	VARA TELESCOPIA 4 MT	1
34995	VARA TELESCOPIA 5 MT	1



Código	Descrição	Cx.
2036	LINHA ARTP BRANCA 0,30 100M/20	40
2037	LINHA ARTP BRANCA 0,35 100M/20	40
2039	LINHA ARTP BRANCA 0,45 100M/20	20
2044	LINHA ARTP BRANCA 0,90 100M/10	20
2045	LINHA ARTP BRANCA 1,00 100M/10	1



Código	Descrição	Cx.
6570	FISGA NO 3 GRANDE 5 PONTAS	1
6571	FISGA NO 8 MEDIA 5 PONTAS	1
24649	FISGA NO 14 PEQUENA 2 PONTAS	1
25835	FISGA NO 15 3 PONTAS	1
6572	FISGA NO 16 PEQUENA 4 PONTAS	1



Código	Descrição	Cx.
4613	REDE FEITIC 0,30X3,50X2,4 X40 M	1
3233	REDE FEITIC 0,30X3,50X2,4X20 M	1
3234	REDE FEITIC 0,30X3,50X2,4X30 M	10
4614	REDE FEITIC 0,30X4,00X2,4X20 M	1
4615	REDE FEITIC 0,30X4,00X2,4X30 M	1
4616	REDE FEITIC 0,30X4,00X2,4X40 M	1
6577	REDE FEITIC 0,40X5,00X2,4X20 M	1
6578	REDE FEITIC 0,40X5,00X2,4X30 M	1
6579	REDE FEITIC 0,40X5,00X2,4X40 M	1
3997	REDE PESCA 0,20X1,20X1,20X 5 M	1
3998	REDE PESCA 0,20X1,20X1,20X10 M	1
23060	REDE PESCA 0,20X1,20X1,20X15 M	1
23309	REDE PESCA 0,20X1,50X1,44X 5 M	1
3990	REDE PESCA 0,20X1,50X1,44X10 M	1
3991	REDE PESCA 0,20X1,50X1,44X15 M	1
3999	REDE PESCA 0,20X1,50X1,44X20 M	1
3256	REDE PESCA 0,20X2,00X1,52X10 M	1
4000	REDE PESCA 0,20X2,00X1,52X15 M	1

Código	Descrição	Cx.
4613	REDE FEITIC 0,30X3,50X2,4 X40 M	1
3233	REDE FEITIC 0,30X3,50X2,4X20 M	1
3234	REDE FEITIC 0,30X3,50X2,4X30 M	10
4614	REDE FEITIC 0,30X4,00X2,4X20 M	1
4615	REDE FEITIC 0,30X4,00X2,4X30 M	1
4616	REDE FEITIC 0,30X4,00X2,4X40 M	1
6577	REDE FEITIC 0,40X5,00X2,4X20 M	1
6578	REDE FEITIC 0,40X5,00X2,4X30 M	1
6579	REDE FEITIC 0,40X5,00X2,4X40 M	1
3997	REDE PESCA 0,20X1,20X1,20X 5 M	1
3998	REDE PESCA 0,20X1,20X1,20X10 M	1
23060	REDE PESCA 0,20X1,20X1,20X15 M	1
23309	REDE PESCA 0,20X1,50X1,44X 5 M	1
3990	REDE PESCA 0,20X1,50X1,44X10 M	1
3991	REDE PESCA 0,20X1,50X1,44X15 M	1
3999	REDE PESCA 0,20X1,50X1,44X20 M	1
3256	REDE PESCA 0,20X2,00X1,52X10 M	1
4000	REDE PESCA 0,20X2,00X1,52X15 M	1

Código	Descrição	Cx.
4001	REDE PESCA 0,20X2,00X1,52X20 M	1
2389	REDE PESCA 0,20X2,50X1,50X20 M	1
4002	REDE PESCA 0,30X3,00X1,50X20 M	1
2391	REDE PESCA 0,30X3,00X1,50X30 M	1
2392	REDE PESCA 0,30X3,00X1,50X40 M	1
4004	REDE PESCA 0,30X3,50X1,75X20 M	1
2394	REDE PESCA 0,30X3,50X1,75X40 M	1
4006	REDE PESCA 0,30X4,00X2,00X20 M	1
4007	REDE PESCA 0,30X4,00X2,00X30 M	1
3992	REDE PESCA 0,30X4,00X2,00X40 M	1
5489	REDE PESCA 0,40X5,00X1,70X20 M	1
5488	REDE PESCA 0,40X5,00X1,70X30 M	1
6374	REDE PESCA 0,40X5,00X1,70X40 M	1
5487	REDE PESCA 0,40X6,00X1,56X20 M	1
5486	REDE PESCA 0,40X6,00X1,56X30 M	1
32907	REDE PESCA 0,40X6,00X1,90X40 M	1
5490	REDE PESCA 0,40X7,00X2,10X20 M	1
6376	REDE PESCA 0,40X7,00X2,10X40 M	4



Código	Descrição	Cx.
6580	TARRAFA MUL.210/6X1,20X1,60 10 M	1
6581	TARRAFA MUL.210/6X1,20X2,10 15 M	1



Código	Descrição	Cx.
31835	LINHA DOURADO BRANCA 0,60 100M ENCART.	1
31838	LINHA DOURADO BRANCA 0,90 100M ENCART.	1
31839	LINHA DOURADO BRANCA 1,00 100M ENCART.	1



Código	Descrição	Cx.
12608	LINHA ARATY BRANCA 0,25 100M ENCART.	1
12611	LINHA ARATY BRANCA 0,40 100M ENCART.	1
12612	LINHA ARATY BRANCA 0,45 100M ENCART.	1
12613	LINHA ARATY BRANCA 0,50 100M ENCART.	1



Código	Descrição	Cx.
13166	LINHA DOURADO BRANCA 0,30 100M C/20 ROL.	1
13167	LINHA DOURADO BRANCA 0,35 100M C/20 ROL.	1
13168	LINHA DOURADO BRANCA 0,40 100M C/20 ROL.	1
13169	LINHA DOURADO BRANCA 0,45 100M C/20 ROL.	1
13170	LINHA DOURADO BRANCA 0,50 100M C/20 ROL.	1
13171	LINHA DOURADO BRANCA 0,60 100M C/10 ROL.	1
13172	LINHA DOURADO BRANCA 0,70 100M C/10 ROL.	1
13173	LINHA DOURADO BRANCA 0,80 100M C/10 ROL.	1
13174	LINHA DOURADO BRANCA 0,90 100M C/10 ROL.	1
13175	LINHA DOURADO BRANCA 1,00 100M C/10 ROL.	1

Código	Descrição	Cx.
13166	LINHA DOURADO BRANCA 0,30 100M C/20 ROL.	1
13167	LINHA DOURADO BRANCA 0,35 100M C/20 ROL.	1
13168	LINHA DOURADO BRANCA 0,40 100M C/20 ROL.	1
13169	LINHA DOURADO BRANCA 0,45 100M C/20 ROL.	1
13170	LINHA DOURADO BRANCA 0,50 100M C/20 ROL.	1
13171	LINHA DOURADO BRANCA 0,60 100M C/10 ROL.	1
13172	LINHA DOURADO BRANCA 0,70 100M C/10 ROL.	1
13173	LINHA DOURADO BRANCA 0,80 100M C/10 ROL.	1
13174	LINHA DOURADO BRANCA 0,90 100M C/10 ROL.	1
13175	LINHA DOURADO BRANCA 1,00 100M C/10 ROL.	1



Código	Descrição	Cx.
4659	ANZOL TRIPLE (GARATEIA) NO 1 C/20	20
4662	ANZOL TRIPLE (GARATEIA) NO 6 C/20	1
4663	ANZOL TRIPLE (GARATEIA) NO 8 C/20	20
4664	ANZOL TRIPLE (GARATEIA) NO 10 C/20	1
24531	ANZOL TRIPLE (GARATEIA) NO .12 C/20	20
4658	ANZOL TRIPLE (GARATEIA) NO 1/0 C/20	1
4657	ANZOL TRIPLE (GARATEIA) NO 2/0 C/20	20
4656	ANZOL TRIPLE (GARATEIA) NO 3/0 C/20	20
4654	ANZOL TRIPLE (GARATEIA) NO 5/0 C/20	20



BASSO PANCOTTE

Produtos para Agropecuária

Anzóis em tamanho real

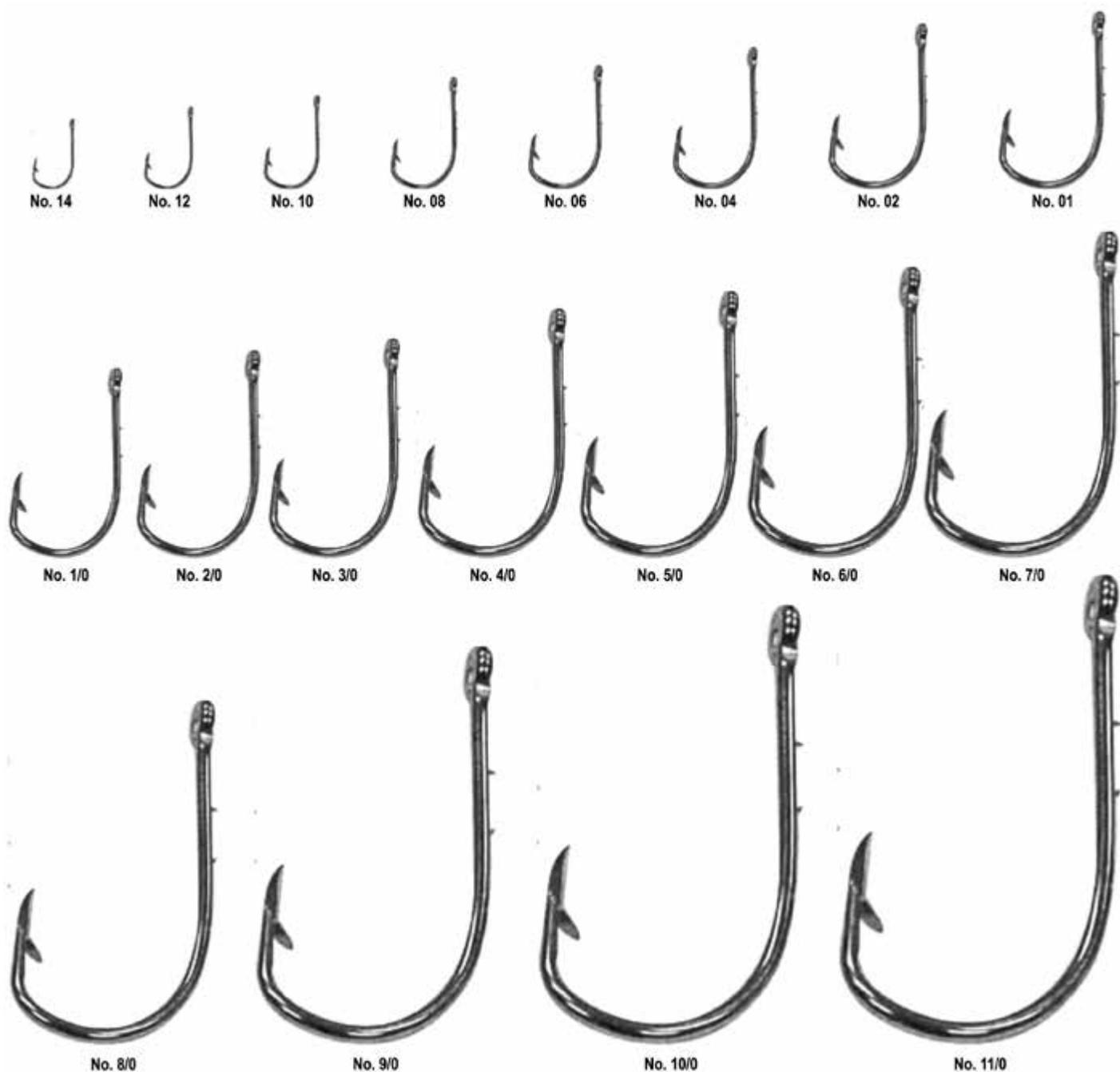

Código	Descrição	Cx.
2191	ANZOL 4330. CX 100 NO 1/0	1
2192	ANZOL 4330. CX 100 NO 2/0	1
2193	ANZOL 4330. CX 100 NO 3/0	1
2194	ANZOL 4330. CX 100 NO 4/0	1
2195	ANZOL 4330. CX 100 NO 5/0	1
2196	ANZOL 4330. CX 100 NO 6/0	1
2198	ANZOL 4330. CX 100 NO 8/0	1
3201	ANZOL 4330. CX 50 NO 9/0	1
3202	ANZOL 4330. CX 50 NO 10/0	1
3203	ANZOL 4330. CX 50 NO 11/0	1

Código	Descrição	Cx.
2189	ANZOL 4330 NO 02 CX 100 PCS	1
2188	ANZOL 4330 NO 04 CX 100 PCS	20
2187	ANZOL 4330 NO 06 CX 100 PCS	1
2186	ANZOL 4330 NO 08 CX 100 PCS	20
2185	ANZOL 4330 NO 10 CX 100 PCS	20
2184	ANZOL 4330 NO 12 CX 100 PCS	20
2183	ANZOL 4330 NO 14 CX 100 PCS	1



BASSO PANCOTTE

Produtos para Agropecuária

Bóias em tamanho real



No. 9



No. 8



No. 7



No. 6



No. 5



No. 4



No. 3



No. 2



No. 1



No. 0

Código	Descrição	Cx.	Código	Descrição	Cx.
3248	BOIA ISOPOR NO 1 C/ 100	1	3255	BOIA ISOPOR NO 7 C/ 50 UNID	1
3250	BOIA ISOPOR NO 2 C/ 100	1	4517	BOIA ISOPOR NO 8 C/ 50 UNID	1
3251	BOIA ISOPOR NO 3 C/ 100	1	26445	BOIA ISOPOR NO 9 C/ 50 UNID	1
3252	BOIA ISOPOR NO 4 C/ 100	1	6568	BOIA ISOPOR NO 10 C/ 50 UNID	12
3253	BOIA ISOPOR NO 5 C/ 100	1	26446	BOIA ISOPOR NO 11 C/ 50 UNID	1
3254	BOIA ISOPOR NO 6 C/ 100	1	6569	BOIA ISOPOR NO 12 C/ 50 UNID	1

Chumbadas em tamanho real



No. 1



No. 2



No. 3



No. 4



No. 5



No. 6



No. 7



No. 8



No. 9



No. 10

Código	Descrição	Cx.	Código	Descrição	Cx.
2089	CHUMBADA NO 1 DE KG OLIVA	20	2094	CHUMBADA NO 6 DE KG OLIVA	20
2090	CHUMBADA NO 2 DE KG OLIVA	20	3457	CHUMBADA NO 7 DE KG OLIVA	20
2091	CHUMBADA NO 3 DE KG OLIVA	20	3458	CHUMBADA NO 8 DE KG OLIVA	20
2092	CHUMBADA NO 4 DE KG OLIVA	20	3459	CHUMBADA NO 9 DE KG OLIVA	20
2093	CHUMBADA NO 5 DE KG OLIVA	20	3460	CHUMBADA NO 10 DE KG OLIVA	20

MAZZAFERRO

DESDE 1953, DESENVOLVENDO
PRODUTOS DE MONO E MULTIFILAMENTOS
DE ALTA QUALIDADE E TECNOLOGIA.



www.mazzaferro.com.br
sac@mazzaferro.com.br
SAC 08000 - 197778

 **Mazzaferro**[®]

Rifle[®]

Ammunition



Premium Series

A linha Premium Series traz chumbos de precisão máxima para competições e competidores de alto nível.



Flathead



Round



Pointed



Thunder

Sport & Field

A linha Sport & Field oferece grande variedade de modelos, chumbos de alta precisão para usos diversos: longas distâncias, field target, benchrest, treino, etc.



Cutter



Dome



Spike



Super
Magnum



Destroyer

Diabolô[®] STR

A tradicional linha Diabolô STR tem os melhores agrupamentos da categoria. De uso geral e de excelente custo-benefício, para atiradores exigentes.



4.5mm



5.5mm



6.0mm



BASSO PANCOTTE

Produtos para Agropecuária

Camping



Código	Descrição	Cx.
4009	TARRAFA BCA 0,25X1,20X1,60 10 M	1
23310	TARRAFA BCA 0,25X1,20X2,50 20 M	1
24717	TARRAFA BCA 0,30X2,00X1,70 10 M	1
4013	TARRAFA BCA 0,30X2,00X2,10 15 M	1
6102	TARRAFA BCA 0,30X2,00X2,50 20 M	1
4011	TARRAFA BCA 0,40X2,00X1,70 10 M	1
4012	TARRAFA BCA 0,40X2,00X1,90 12 M	1
24562	TARRAFA BCA 0,40X2,00X2,10 15 M	1
4014	TARRAFA BCA 0,40X2,00X2,50 20 M	1
4555	TARRAFA BCA 0,40X3,00X2,10 15 M	1
4556	TARRAFA BCA 0,40X3,00X2,50 20 M	1
31918	TARRAFA BCA 0,50X3,5X3,50 30 M	1
31919	TARRAFA BCA 0,60X5,0X3,50 30 M	1



Código	Descrição	Cx.
29054	TUBO LATEX C/15 M MANG. SORO R.200 FINA	1
25152	TUBO LATEX C/15 M MANG. SORO R.201 MEDIA	1
29055	TUBO LATEX C/15 M MANG SORO R.202 GROSSA	1



Código	Descrição	Cx.
10590	MACACAO PVC PES REF 3005 C/BOTA PVC Nº40	5
10591	MACACAO PVC PES REF 3005 C/BOTA PVC Nº41	5
10592	MACACAO PVC PES REF 3005 C/BOTA PVC Nº42	5
10593	MACACAO PVC PES REF 3005 C/BOTA PVC Nº43	5



Código	Descrição	Cx.
8074	CHUMBINHO RIFLE 4,5 MM FLAT HEAD C/250un	48
8075	CHUMBINHO RIFLE 5,5 MM FLAT HEAD C/125un	48



Código	Descrição	Cx.
8076	CHUMBINHO RIFLE 4,5 MM ROUND C/250un	48
8077	CHUMBINHO RIFLE 5,5 MM ROUND C/125un	48



Código	Descrição	Cx.
34893	CHUMBINHO GAMO EXPAN 4,5 MM CX C/250	60
34495	CHUMBINHO GAMO EXPAN 5,5 MM CX C/250	60



Código	Descrição	Cx.
35533	CHUMBINHO GAMO ROCKET 5,5MM CX C/100 UNID	48



Código	Descrição	Cx.
33749	CHUMBINHO GAMO PRO 4,5 MM CX C/250	100
33748	CHUMBINHO GAMO PRO 5,5 MM CX C/250	100



Código	Descrição	Cx.
35531	CHUMBINHO GAMO MAGNUM 4,5 MM CX C/250	100
34326	CHUMBINHO GAMO MAGNUM 5,5 MM CX C/250	100



Código	Descrição	Cx.
8078	CHUMBINHO RIFLE 4,5 MM POINTED C/250un	48



Código	Descrição	Cx.
29555	CHUMBINHO RIFLE 4,5 MM STR CX C/250	100
29556	CHUMBINHO RIFLE 5,5 MM STR CX C/125	100



BASSO PANCOTTE

Produtos para Agropecuária

Camping



Código	Descrição	Cx.
8085	CHUMBINHO RIFLE 6,0 MM CX c/100 un	100



Código	Descrição	Cx.
8079	CHUMBINHO RIFLE 5,5 MM POINTED C/125un	48



Código	Descrição	Cx.
33232	CHUMBINHO GAMO MATCH 4,5 MM CX C/250	100
33233	CHUMBINHO GAMO MATCH 5,5 MM CX C/250	100



Código	Descrição	Cx.
37555	CHUMBO ESPORTIVO " 1 T " 1 KG	20
5970	CHUMBO ESPORTIVO " 2 T " 1 KG	20
5971	CHUMBO ESPORTIVO " 3 T " 1 KG	20
5972	CHUMBO ESPORTIVO " S G " 1 KG	20
5967	CHUMBO ESPORTIVO NO 1 DE 1 KG	20
5968	CHUMBO ESPORTIVO NO 2 DE 1 KG	20
5965	CHUMBO ESPORTIVO NO 3 DE 1 KG	20
5969	CHUMBO ESPORTIVO NO 4 DE 1 KG	20
2665	CHUMBO ESPORTIVO NO 5 DE 1 KG	20
5966	CHUMBO ESPORTIVO NO 6 DE 1 KG	20
5964	CHUMBO ESPORTIVO NO 7 DE 1 KG	20
5963	CHUMBO ESPORTIVO NO 8 DE 1 KG	20
5962	CHUMBO ESPORTIVO NO 9 DE 1 KG	20
5961	CHUMBO ESPORTIVO NO.10 DE 1 KG	20



Código	Descrição	Cx.
35532	CHUMBINHO GAMO RED FIRE 4,5MM CX C/125 UNID	24



Código	Descrição	Cx.
9230	CARABINA CBC JADE PRO 5.5mm C.PP	1



Código	Descrição	Cx.
8622	CARABINA CBC JADE OX 4.5mm PP	1
7018	CARABINA CBC JADE OX 5.5mm PP	1



Código	Descrição	Cx.
3097	CARABINA CBC B12-6 4,5mm C. MADEIRA	1



Código	Descrição	Cx.
37972	CARABINA CBC NITRO ADVANCED F22 5.5mm	1



Código	Descrição	Cx.
38008	CARABINA CBC NITRO SIX 6,0mm	1



Código	Descrição	Cx.
4036	CARABINA CBC JADE MAIS 5.5mm PP	5



CARABINAS DE PRESSÃO CBC

UMA EXPERIÊNCIA INESQUECÍVEL

JADE



CALIBRE 4,5 mm (.177)
Velocidade 700 pés/seg (213 m/s)

CALIBRE 5,5 mm (.22)
Velocidade 550 pés/seg (168 m/s)

JADE MAIS



CALIBRE 4,5 mm (.177)
Velocidade 700 pés/seg (213 m/s)

CALIBRE 5,5 mm (.22)
Velocidade 550 pés/seg (168 m/s)

CORONHA DISPONÍVEL NAS CORES: ● ● ● ● ●

JADE PRO



CALIBRE 4,5 mm (.177)
Velocidade 900 pés/seg (274 m/s)

CALIBRE 5,5 mm (.22)
Velocidade 700 pés/seg (213 m/s)

CORONHA DISPONÍVEL NAS CORES: ● ● ● ● ●

B12-6



CALIBRE 4,5 mm (.177)
Velocidade 600 pés/seg (183 m/s)

CALIBRE 5,5 mm (.22)
Velocidade 530 pés/seg (162 m/s)

NITRO ADVANCED



CALIBRE 4,5 mm (.177)
Velocidade 1000 pés/seg (305 m/s)

CALIBRE 5,5 mm (.22)
Velocidade 800 pés/seg (244 m/s)

NITRO SIX 6MM



CALIBRE 6 mm (.236)
Velocidade 850 pés/seg (260 m/s)

TAMBÉM DISPONÍVEL COM ACABAMENTO CROMADO



BASSO PANCOTTE

Produtos para Agropecuária

Pecuária



Código	Descrição	Cx.
792	ALICATE ELASTADOR ZINCADO NACIONAL - BASPAN	1



Código	Descrição	Cx.
10351	ALICATE FERRADOR "JACARE" BASPAN	25



Código	Descrição	Cx.
10779	TESOURA CASCO OVINO/SUINO BASPAN	25



Código	Descrição	Cx.
625	TACO PARA CASCO DE VACA PVC DEDO DIREITO	10
697	TACO PARA CASCO DE VACA PVC DEDO ESQUER	10



Código	Descrição	Cx.
559	ALICATE ELASTADOR P/ COLOCAR ANEL ARTIFICE	10



Código	Descrição	Cx.
560	ANEL CASTRACAO C/100 ARTIFICE	1



Código	Descrição	Cx.
1461	CORRENTE PARA VACA C/1 UNID	50



Código	Descrição	Cx.
34325	ANEL CASTRACAO IMP. LARAN C/100 WALMUR	1
2934	ANEL CASTRACAO IMP. VERDE C/100 WALMUR	1



Código	Descrição	Cx.
4518	ALICATE FORMIGA 20 CM ARTIFICE	25
4563	ALICATE FORMIGA 30 CM ARTIFICE	1



Código	Descrição	Cx.
35267	PICANA FERRO ELET RECAREGAVEL 9V R ZEBU	1



Código	Descrição	Cx.
27001	FORMIGA ALICATE C/MOLA ELIO FERNANDES	25



BASSO PANCOTTE

Produtos para Agropecuária

Pecuária



Código	Descrição	Cx.
6505	AGULHA APLIC.BRINCO ALLFLEX C/2 UNID.S/ PONTA	1

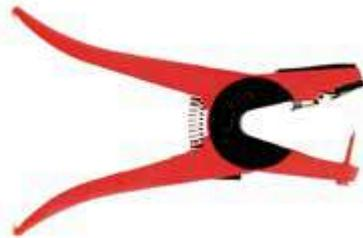

Código	Descrição	Cx.
5140	APLICADOR DE BRINCO ALLFLEX	1



Código	Descrição	Cx.
33727	APLICADOR DE BRINCO C/ AG. BASPAN	83



Código	Descrição	Cx.
35644	APLICADOR DE BRINCO C/ AG. BASPAN TAG	1



Código	Descrição	Cx.
4144	AGULHA APL.BRINCO C/PONTA C/2 UNID. CRISAN	1



Código	Descrição	Cx.
26517	AGULHA APL.BRINCO S/PONTA C/2 UNID. CRISAN	1



Código	Descrição	Cx.
28687	APLICADOR BRINCO CRISAN "NYLON" AG. MOVEL	1



Código	Descrição	Cx.
4143	APLICADOR BRINCO CRISAN METAL ALUMINIO	24



Código	Descrição	Cx.
727	AGULHA APLIC.BRINCO WALMUR	1



Código	Descrição	Cx.
32317	APLICADOR DE BRINCO QUALYPLAST SISBOV	100



Código	Descrição	Cx.
6059	ARGOLA NARIZ TOURO NO 08 C/PARAF R.54	1
6060	ARGOLA NARIZ TOURO NO 09 C/PARAF R.55	100
6061	ARGOLA NARIZ TOURO NO 10 C/PARAF R.56	100



Código	Descrição	Cx.
4277	ARGOLA NARIZ TOURO 80MM SERVI	25
22718	ARGOLA NARIZ TOURO 90MM SERVI	25



BASSO PANCOTTE

Produtos para Agropecuária

Pecuária



Código	Descrição	Cx.
23607	BRINCO BOV GR AMARELO S/NO C/25	30



Código	Descrição	Cx.
23599	BRINCO BOV GR AMARELO 1 A 25	30
23600	BRINCO BOV GR AMARELO 26 A 50	30
23601	BRINCO BOV GR AMARELO 51 A 75	30
23602	BRINCO BOV GR AMARELO 76 A 100	30
23603	BRINCO BOV GR AMARELO 101 A 125	30
23604	BRINCO BOV GR AMARELO 126 A 150	30
23605	BRINCO BOV GR AMARELO 151 A 175	30
23606	BRINCO BOV GR AMARELO 176 A 200	30
31802	BRINCO BOV GR AMARELO 201 A 225	30

Código	Descrição	Cx.
31803	BRINCO BOV GR AMARELO 226 A 250	30
31804	BRINCO BOV GR AMARELO 251 A 275	30
31805	BRINCO BOV GR AMARELO 276 A 300	30
31806	BRINCO BOV GR AMARELO 301 A 325	30
31807	BRINCO BOV GR AMARELO 326 A 350	30
31808	BRINCO BOV GR AMARELO 351 A 375	30
31809	BRINCO BOV GR AMARELO 376 A 400	30



Código	Descrição	Cx.
4910	BRINCO BOV GR AZUL 1 A 25	30
4911	BRINCO BOV GR AZUL 26 A 50	30
4912	BRINCO BOV GR AZUL 51 A 75	30
4913	BRINCO BOV GR AZUL 76 A 100	30



Código	Descrição	Cx.
23908	BRINCO BOV GR BRANCO S/NO C/25	30
23913	BRINCO BOV GR VERDE S/NO C/25	30



Código	Descrição	Cx.
23878	BRINCO BOV GR VERMELHO 1 A 25	30
23882	BRINCO BOV GR VERMELHO 26 A 50	30
23886	BRINCO BOV GR VERMELHO 51 A 75	30
23890	BRINCO BOV GR VERMELHO 76 A 100	30



Código	Descrição	Cx.
23914	BRINCO BOV GR VERMELHO S/NO C/25	30



Código	Descrição	Cx.
27931	BRINCO BOV MED AZUL 1 A 25 AGROBRINCO	30
27932	BRINCO BOV MED AZUL 26 A 50 AGROBRINCO	30
27933	BRINCO BOV MED AZUL 51 A 75 AGROBRINCO	30
27934	BRINCO BOV MED AZUL 76 A 100 AGROBRINCO	30



Código	Descrição	Cx.
27930	BRINCO BOV MED AMARELO S/NO AGROBRINCO	30



Código	Descrição	Cx.
27943	BRINCO BOV MED AZUL S/NO C/25 AGROBRINCO	30



Código	Descrição	Cx.
27918	BRINCO BOV MED AMARELO 1 A 25 AGROBRINCO	30
27919	BRINCO BOV MED AMARELO 26 A 50 AGROBRINCO	30
27920	BRINCO BOV MED AMARELO 51 A 75 AGROBRINCO	30
27921	BRINCO BOV MED AMARELO 76 A 100 AGROBRINCO	30
27922	BRINCO BOV MED AMARELO 101 A 125 AGROBRINCO	30
27923	BRINCO BOV MED AMARELO 126 A 150 AGROBRINCO	30
27924	BRINCO BOV MED AMARELO 151 A 175 AGROBRINCO	30

Código	Descrição	Cx.
27925	BRINCO BOV MED AMARELO 176 A 200 AGROBRINCO	30
27926	BRINCO BOV MED AMARELO 201 A 225 AGROBRINCO	30
27927	BRINCO BOV MED AMARELO 226 A 250 AGROBRINCO	30
27928	BRINCO BOV MED AMARELO 251 A 275 AGROBRINCO	30
27929	BRINCO BOV MED AMARELO 276 A 300 AGROBRINCO	30
31762	BRINCO BOV MED AMARELO 301 A 325 AGROBRINCO	30
31763	BRINCO BOV MED AMARELO 326 A 350 AGROBRINCO	30
31764	BRINCO BOV MED AMARELO 351 A 375 AGROBRINCO	30
31765	BRINCO BOV MED AMARELO 376 A 400 AGROBRINCO	30



BASSO PANCOTTE

Produtos para Agropecuária

Pecuária



Código	Descrição	Cx.
27945	BRINCO BOV MED BRANCO 26 A 50 AGROBRINCO	30



Código	Descrição	Cx.
27983	BRINCO BOV MED VERMELHO 1 A 25 AGROBRI	30
27984	BRINCO BOV MED VERMELHO 26 A 50 AGROBRI	30
27985	BRINCO BOV MED VERMELHO 51 A 75 AGROBRI	30
27986	BRINCO BOV MED VERMELHO 76 A 100 AGROBRI	30



Código	Descrição	Cx.
27995	BRINCO BOV MED VERMELHO S/NO AGROBRINCO C/25	30



Código	Descrição	Cx.
7359	BRINCO BOV GR AZUL S/Nº CRISAN	40



Código	Descrição	Cx.
7361	BRINCO BOV GR BRANCO S/Nº CRISAN	40



Código	Descrição	Cx.
7360	BRINCO BOV GR VERDE S/Nº CRISAN	40



Código	Descrição	Cx.
7349	BRINCO BOV GR AMARELO 01 A 25 CRISAN	40
7350	BRINCO BOV GR AMARELO 26 A 50 CRISAN	40
7352	BRINCO BOV GR AMARELO 51 A 75 CRISAN	40
7351	BRINCO BOV GR AMARELO 76 A 100 CRISAN	40
7353	BRINCO BOV GR AMARELO 101 A 125 CRISAN	40
7354	BRINCO BOV GR AMARELO 126 A 150 CRISAN	40
7355	BRINCO BOV GR AMARELO 151 A 175 CRISAN	40
7356	BRINCO BOV GR AMARELO 176 A 200 CRISAN	40



Código	Descrição	Cx.
7357	BRINCO BOV GR AMARELO S/Nº CRISAN	40
23620	BRINCO BOV MED AMARELO S/NO C/25 CRISAN	40



Código	Descrição	Cx.
7358	BRINCO BOV GR VERMELHO S/Nº CRISAN	40



Código	Descrição	Cx.
23608	BRINCO BOV MED AMARELO 1 A 25 CRISAN	40
23609	BRINCO BOV MED AMARELO 26 A 50 CRISAN	40
23610	BRINCO BOV MED AMARELO 51 A 75 CRISAN	40
23611	BRINCO BOV MED AMARELO 76 A 100 CRISAN	40
23612	BRINCO BOV MED AMARELO 101 A 125 CRISAN	40
23613	BRINCO BOV MED AMARELO 126 A 150 CRISAN	40
23614	BRINCO BOV MED AMARELO 151 A 175 CRISAN	40

Código	Descrição	Cx.
23615	BRINCO BOV MED AMARELO 176 A 200 CRISAN	40
23616	BRINCO BOV MED AMARELO 201 A 225 CRISAN	40
23617	BRINCO BOV MED AMARELO 226 A 250 CRISAN	40
23618	BRINCO BOV MED AMARELO 251 A 275 CRISAN	40
23619	BRINCO BOV MED AMARELO 276 A 300 CRISAN	40
33209	BRINCO BOV MED AMARELO 301 A 400 CRISAN	1
33210	BRINCO BOV MED AMARELO 401 A 500 CRISAN	1



Código	Descrição	Cx.
4412	BRINCO BOV MED AZUL 1 A 25 CRISAN	40
4413	BRINCO BOV MED AZUL 26 A 50 CRISAN	40
4414	BRINCO BOV MED AZUL 51 A 75 CRISAN	40
4415	BRINCO BOV MED AZUL 76 A 100 CRISAN	40



BASSO PANCOTTE

Produtos para Agropecuária

Pecuária



Código	Descrição	Cx.
4918	BRINCO BOV MED AZUL S/NO C/25 UN CRISAN	40



Código	Descrição	Cx.
23979	BRINCO BOV MED BRANCO S/NO C/25 CRISAN	40



Código	Descrição	Cx.
4424	MACHO BRINCO C/25 AMARELO PONTA METAL	1
24058	MACHO BRINCO C/25 BRANCO PONTA METAL	10
24061	MACHO BRINCO C/25 LARANJA PONTA METAL	10
24059	MACHO BRINCO C/25 VERDE PONTA METAL	1



Código	Descrição	Cx.
23911	BRINCO BOV MED VERMELHO 1 A 25 CRISAN	40
23918	BRINCO BOV MED VERMELHO 26 A 50 CRISAN	40
23941	BRINCO BOV MED VERMELHO 51 A 75 CRISAN	40
23945	BRINCO BOV MED VERMELHO 76 A 100 CRISAN	40



Código	Descrição	Cx.
23981	BRINCO BOV MED VERMELHO S/NO C/25 CRISAN	40



Código	Descrição	Cx.
641	DESMAMADOR C/REGUL C/5 UNID. BOVITEC	1



Código	Descrição	Cx.
25412	CANETA MARCADOR BRINCO TAG PEN AGROBRINCO	1



Código	Descrição	Cx.
1089	CANETA SINALAR BRINCO ALLFLEX	100



Código	Descrição	Cx.
5806	COCHO SAL / VOLUMOSO CAP.105 L	1



Código	Descrição	Cx.
23630	BRINCO SUINO AMARELO 1 A 25	30
23631	BRINCO SUINO AMARELO 26 A 50	30
23632	BRINCO SUINO AMARELO 51 A 75	30
23633	BRINCO SUINO AMARELO 76 A 100	30
23634	BRINCO SUINO AMARELO 101 A 125	30
23635	BRINCO SUINO AMARELO 126 A 150	30
23636	BRINCO SUINO AMARELO 151 A 175	30
23637	BRINCO SUINO AMARELO 176 A 200	30



Código	Descrição	Cx.
23638	BRINCO SUINO AMARELO S/NO C/25	30



BASSO PANCOTTE

Produtos para Agropecuária

Pecuária



Código	Descrição	Cx.
958	BRINCO SUINO AZUL S/NO PC C/25	30



Código	Descrição	Cx.
24055	BRINCO SUINO BRANCO S/NO C/25	30



Código	Descrição	Cx.
24054	BRINCO SUINO VERDE S/NO C/25	30



Código	Descrição	Cx.
23629	BRINCO OVINO AMARELO S/NO C/25	40



Código	Descrição	Cx.
24016	BRINCO OVINO VERDE S/NO C/25	40



Código	Descrição	Cx.
4146	BRINCO OVINO AZUL S/NO C/25 UN	40

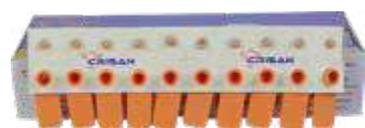

Código	Descrição	Cx.
24018	BRINCO OVINO LARANJA S/NO C/25	40



Código	Descrição	Cx.
23621	BRINCO OVINO AMARELO 1 A 25	40
23622	BRINCO OVINO AMARELO 26 A 50	40
23623	BRINCO OVINO AMARELO 51 A 75	40
23624	BRINCO OVINO AMARELO 76 A 100	40
23625	BRINCO OVINO AMARELO 101 A 125	40
23626	BRINCO OVINO AMARELO 126 A 150	40
23627	BRINCO OVINO AMARELO 151 A 175	40
23628	BRINCO OVINO AMARELO 176 A 200	40
31936	BRINCO OVINO AMARELO 201 A 225	40
31937	BRINCO OVINO AMARELO 226 A 250	40
31941	BRINCO OVINO AMARELO 251 A 275	40
31943	BRINCO OVINO AMARELO 276 A 300	40



Código	Descrição	Cx.
5247	DESMAMADOR S/REGUL C/5 UNID. BOVITEC	20



Código	Descrição	Cx.
24523	DESMAMADOR PLASTICO C/PINO C/10 UNID. ELIO FERNANDES	1



CRISAN





BASSO PANCOTTE

Produtos para Agropecuária

Pecuária

		
Código	Descrição	Cx.
37747	PINO P/DESMAMADOR C/10 unid ELIO FERNANDES	1

		
Código	Descrição	Cx.
3051	DESMAMADOR TABULETA GRANDE C/50 UNID. PACOTE	1

		
Código	Descrição	Cx.
3132	EMBORNAL ARAME	1

		
Código	Descrição	Cx.
25848	GUIZO COM FERRAO ELIO FERNANDES	20

		
Código	Descrição	Cx.
2969	GUIZO COM ROSETA ELIO FERNANDES	50

		
Código	Descrição	Cx.
1702	LEVANTA SEGURADOR DE GADO WALMUR	1

		
Código	Descrição	Cx.
1182	BICO DE MAMADEIRA LATEX CRISAN C/10 UNID.	25

		
Código	Descrição	Cx.
1181	MAMADEIRA BICO LATEX BEZERRO BP "CRISAN"	50

		
Código	Descrição	Cx.
1697	BICO DE MAMADEIRA BEZERRO BORRACHA C/10 UNID.	15

		
Código	Descrição	Cx.
649	BICO DE MAMADEIRA BEZERRO C/24 UNID. FAZFORT	1



		
Código	Descrição	Cx.
37795	BICO DE MAMADEIRA CAPRINO C/10 UNID. FAZFORT	1



BASSO PANCOTTE

Produtos para Agropecuária

Pecuária



Código	Descrição	Cx.
24560	MAMADEIRA BEZER.SGAMAQ BICO BORRAC. 2 L	32



Código	Descrição	Cx.
1935	TAMPA MAMADEI. SGAMAQ.C/ ROSCA C/5 UNID.	1



Código	Descrição	Cx.
35691	MANEADEIRA - IMOBILIZ.P/VACA REFORCADA BASPAN	1



Código	Descrição	Cx.
430	MANEADEIRA - IMOBILIZ.P/VACA	20



Código	Descrição	Cx.
12913	MARCADOR 9 BRUCELOSE	1



Código	Descrição	Cx.
11361	MARCADOR V BRUCELOSE	50



Código	Descrição	Cx.
4844	AQUEC.GAS 2 BOCAS PEQ METALPEC VERMELHO	4



Código	Descrição	Cx.
4843	AQUEC.GAS 9 BOCA GRANDE METALPEC VERMELHO	2



Código	Descrição	Cx.
26731	JOGO CARIMBO FERRO 40 MM NO 0 A 9	1
4846	JOGO CARIMBO FERRO 50 MM NO 0 A 9	4
4845	JOGO CARIMBO FERRO 70 MM NO 0 A 9	1



Código	Descrição	Cx.
35795	TATUADEIRA BOVINOS/SUINOS 6DIG 10MM COD 2767 WALMUR	1



Código	Descrição	Cx.
541	BOVICOR 45 G	1



Código	Descrição	Cx.
2968	DESCORNADOR CORTA ELIO FERNANDES SIMPLES	1



BASSO PANCOTTE

Produtos para Agropecuária

Pecuária

		
Código	Descrição	Cx.
5355	DESCORNADOR REFORCADO ELIO FERNANDES	5

		
Código	Descrição	Cx.
9194	MOCHADOR ELETRICO 127V 240W FAZENDEIRO	12
9195	MOCHADOR ELETRICO 220V 240W FAZENDEIRO	12

		
Código	Descrição	Cx.
23725	MOCHADOR DE COBRE BP MARTELO	12

		
Código	Descrição	Cx.
23353	MOCHADOR DE COBRE BP RETO	1

		
Código	Descrição	Cx.
23352	MOCHADOR DE FERRO BP RETO	1

		
Código	Descrição	Cx.
1700	SERRA P/CHIFRES E EMBRIOTOMIA	50

		
Código	Descrição	Cx.
6623	MOCHADOR ELETRICO 2 ERAS PB 127V	30
6622	MOCHADOR ELETRICO 2 ERAS PB 220V	30

		
Código	Descrição	Cx.
674	FITA PARA PESAGEM DE GADO	1

		
Código	Descrição	Cx.
4026	TOSQUIADEIRA OVINOS 220 V BASPAN 60 HZ	1

		
Código	Descrição	Cx.
791	TESOURA TOSQUIA BASPAN (NACIONAL) 12' PEQ	25

		
Código	Descrição	Cx.
33183	TESOURA TOSQUIA BASPAN (NACIONAL) 13'	25

		
Código	Descrição	Cx.
1441	TESOURA TOSQUIA ERVAL	12



BASSO PANCOTTE

Produtos para Agropecuária

Pecuária



Código	Descrição	Cx.
7297	CORTANTE MOVEL MAXISHEAR F7 OVINOS WALMUR	1



Código	Descrição	Cx.
7511	PENTE BEYUAN 3" 13 DENTES CURVO P/ OVINOS	1



Código	Descrição	Cx.
4291	CAMPANULA A LUZ DE ALUMINIO ZATTI	1



Código	Descrição	Cx.
23093	ARRUELA BOR.BEB.PENDULAR C/10 UNID. PACOTE	1



Código	Descrição	Cx.
32547	BEBED PENDULAR AVES C/5 UNID BASPAN	1



Código	Descrição	Cx.
37834	KIT PECAS BEBED PENDULAR	1



Código	Descrição	Cx.
37865	MANGUEIRA BEBED PENDULAR C/4 UND	1



Código	Descrição	Cx.
6089	RAMAL BEBED PENDULAR C/10 UNID	1



Código	Descrição	Cx.
37866	TUBO FLUXO BEBED PENDULAR C/4 UNID	1



Código	Descrição	Cx.
33354	VALVULA P/BEB.PEND. PACOTE C/5 UNID. BASPAN	10



Código	Descrição	Cx.
9514	BEBED FRANGO BEMAC 2 L C/ROSCA C/6 UNID.	1
9515	BEBED FRANGO BEMAC 5 L C/ROSCA C/6 UNID.	1
9516	BEBED FRANGO BEMAC 7,5 L C/ROSCA C/6 UNID.	1



Código	Descrição	Cx.
22721	BEBED FRANGO 2 L (CRISAN) C/6 UNID. PACOTE	1
22722	BEBED FRANGO 5 L (CRISAN) C/6 UNID. PACOTE	1



BASSO PANCOTTE

Produtos para Agropecuária

Pecuária



Código	Descrição	Cx.
28335	COMED TUBUL FRANGO 3 KG PLASTICO CRISAN	6



Código	Descrição	Cx.
27271	COMED TUBUL 15 KG PRAT.PLAST.C/4 FADELLI	1



Código	Descrição	Cx.
1758	COMED CALHA 30CM C/4 UNID.PACOTE	1
1757	COMED CALHA 50CM C/4 UNID.PACOTE	1
1756	COMED CALHA 1 M C/4 UNID.PACOTE	1



Código	Descrição	Cx.
26776	COMED TUBU. 20 KG PRATO PLAST. C/2 UN	1
25614	COMED TUBU. 3 KG PRATO PLAST. C/4 UN	1
25615	COMED TUBU. 5 KG PRATO PLAST. C/4 UN	1



Código	Descrição	Cx.
1759	COMED TUBULAR ZATTI 3 KG C/4 UN	1
1760	COMED TUBULAR ZATTI 6 KG C/4 UN	1
1761	COMED TUBULAR ZATTI 25 KG C/2 UN	1



Código	Descrição	Cx.
35163	BEBED FRANGO ECOLOGICO GARRAF PET C/6 UNID	1



Código	Descrição	Cx.
1486	COMED AVES SIFAO C/GARRA 3 KG PACOTE 6 UNID.	1



Código	Descrição	Cx.
34155	ALIMENTADOR FLEX (RACAO AGUA) 6X2,5 L CX C/6	1



Código	Descrição	Cx.
35798	TINTA TATUADORA PRETA BISNAGA 40G REF 025.905 FC	1



Código	Descrição	Cx.
2737	BEBED CHUPETA COELHO C/5 UNID. PACOTE	100

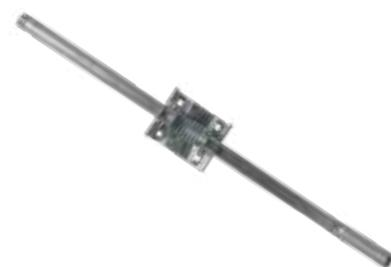

Código	Descrição	Cx.
1936	BEBED MOVEL C/MOLA 1 S. 70CM CANO COMPRIDO	10



BASSO PANCOTTE

Produtos para Agropecuária

Pecuária



Código	Descrição	Cx.
4075	BEBED MOVEL C/MOLA 1 SAIDA 53CM	10



Código	Descrição	Cx.
29593	BEBED MOVEL C/MOLA 2 S. 70CM C.COMP S/ ADAPTADOR	10



Código	Descrição	Cx.
4669	BEBED MOVEL C/MOLA 2 SAIDA 53CM S/ ADAPTADOR	10



Código	Descrição	Cx.
29292	BEBED MOVEL PENDULAR 1 SAIDA C/CORRENTE	10
29291	BEBED MOVEL PENDULAR 2 SAIDA C/CORRENTE	10



Código	Descrição	Cx.
26040	CANO DO BEBED. MOVEL 1 SAIDA (SÓ O CANO) 53CM	10



Código	Descrição	Cx.
36561	CANO DO BEBED. MOVEL 1 SAIDA 70CM COMPRID	10



Código	Descrição	Cx.
26460	CANO DO BEBED. MOVEL 2 SAIDA (SÓ O CANO) 53CM	1



Código	Descrição	Cx.
29701	CONJ PECAS BEBED MOVEL (MOLA+CHAPAS)	10



Código	Descrição	Cx.
7513	BEBED MOVEL C/MOLA REFORCADO 1 SAIDA 45° CANO INOX 60CM	1



Código	Descrição	Cx.
8644	BEBED MOVEL C/MOLA REFORCADO 2 SAIDA 45° GALV. 60cm	1



Código	Descrição	Cx.
35257	BEBED CHUPETA BASPAN INOX CRECHE 16E C/5 UNID	50



Código	Descrição	Cx.
35255	BEBED CHUPETA BASPAN INOX MATERNID C/1 UNID13E	100



BASSO PANCOTTE

Produtos para Agropecuária

Pecuária



Código	Descrição	Cx.
35259	BEBED CHUPETA BASPAN INOX NIPLE UMIDEC C/5 6TP	50



Código	Descrição	Cx.
35256	BEBED CHUPETA BASPAN INOX TERMINACAO C/5 UNID.12E	40



Código	Descrição	Cx.
35258	BEBED CHUPETA BASPAN INOX UMIDEC.CURTO C/SUNID.20E	40



Código	Descrição	Cx.
35260	BEBED VALVULA BASPAN INOX C/5 UNID.10IC	50



Código	Descrição	Cx.
35762	BORRACHA BEBED BASPAN (12E,13E,20E,06) C/10 UND	200



Código	Descrição	Cx.
35763	BORRACHA BEBED BASPAN 16E C/10 UND CRECHE	1



Código	Descrição	Cx.
35264	CONECTOR BASPAN INOX 45° 1/2 8SS C/5	20



Código	Descrição	Cx.
35766	FILTRO REGULAV BEBED BASPAN C/5 UNID	1



Código	Descrição	Cx.
35765	MOLA BEBED. CHUPETA BASPAN (12E,13E,20E,06) C/10 UND	1



Código	Descrição	Cx.
35764	MOLA BEBED. CHUPETA BASPAN 16E C/10 UND CRECHE	1



Código	Descrição	Cx.
1789	ADAPTADOR CHUP. RED.ALUMINIO C/5 UNID PACOTE	20



Código	Descrição	Cx.
714	BEBED CHUPETA LATAO INFANTIL C/5 UNID.	1
713	BEBED CHUPETA LATAO MEDIA C/5 UNID.	30
68	BEBED CHUPETA LATAO ADULTO C/5 UNID.	1



BASSO PANCOTTE

Produtos para Agropecuária

Pecuária



Código	Descrição	Cx.
32357	BEBED CHUPETA NIPLE UMIDEC. INOX C/5 UNID.	30



Código	Descrição	Cx.
23333	BEBED CHUPETA NIPLE UMIDECEDOR C/5 UNID.	30



Código	Descrição	Cx.
1123	BEBED CHUPETA PRESSAO C/5 UNID. PACOTE	1



Código	Descrição	Cx.
23087	BEBED CHUPETA S/MOLA C/5 UNID. PACOTE	30



Código	Descrição	Cx.
691	BEBED ECOLOGICO SUINOS TERMINACAO (PLASTICO)	10



Código	Descrição	Cx.
24071	BEBED VALVULA ECOLOGICO "SUINOS" C/5 UNID. PACOTE	30



Código	Descrição	Cx.
380	BEBED VALVULA MEXICANA C/5 UNID. PACOTE	30



Código	Descrição	Cx.
817	BORRACHA BEBED. CHUPETA AD/MD/INF C/10 UNID	1



Código	Descrição	Cx.
27333	BORRACHA P/BEB ECOLO E MEXICANA C/10 UNID.	50



Código	Descrição	Cx.
4906	CONECTOR ALUM. RETO 1/2 C/5 UNID. PACOTE	20



Código	Descrição	Cx.
4905	CONECTOR ALUM.450 1/2 CURVO C/5 UNID. PACOTE	20



Código	Descrição	Cx.
8360	CONECTOR PLASTICO RETO 1/2 C/5 UNID. PACOTE	20



BASSO PANCOTTE

Produtos para Agropecuária

Pecuária



Código	Descrição	Cx.
379	FILTRO REGUL P/CHUPETA PLASTICO C/10 UNID. PACOTE	1



Código	Descrição	Cx.
383	MOLA BEBED. CHUPETA ADULTO/MEDIA C/10 UN VAL ECOL/MEXIC	100



Código	Descrição	Cx.
10408	MOLA BEBED. CHUPETA ADULTO/MEDIA C/100 UN VAL ECOL/MEXIC	1



Código	Descrição	Cx.
23459	MOLA BEBED. CHUPETA INFANTIL C/10 UNID.	100



Código	Descrição	Cx.
3281	LAMPADA SECAGEM 100W INCAND REFLET 220V EMPALUX	100



Código	Descrição	Cx.
23737	LAMPADA SECAGEM 250W INFR.VERM 220V EMPALUX	24



Código	Descrição	Cx.
4472	ALICATE FC APLICAR GRAMPO SUINOS - CABO PLASTICO	1

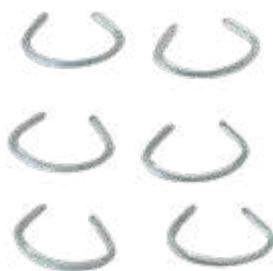

Código	Descrição	Cx.
4473	GRAMPO PARA SUINOS CX C/ 200 - FC	1



Código	Descrição	Cx.
12335	CERA ALVEOL.P/ABELHA 42X20CM C/20 LAMINAS PACOTE	1



Código	Descrição	Cx.
3036	LUVA APICULTURA NAPA	10



Código	Descrição	Cx.
1456	LUVA APICULTURA VAQUETA	10



BASSO PANCOTTE

Produtos para Agropecuária

Pecuária



Código	Descrição	Cx.
1453	MASCARA P/ APICULTURA C/CHAPEU BAND	1



Código	Descrição	Cx.
4163	JALECO APICULT. BRANCO C/MASCARA	1



Código	Descrição	Cx.
5897	MACACAO APIC. C/MASCARA "EXG"	1
5895	MACACAO APIC. C/MASCARA "G"	1
5896	MACACAO APIC. C/MASCARA "GG"	1
1613	MACACAO APIC. C/MASCARA "MED"	1



Código	Descrição	Cx.
35426	MACACAO APIC. NYLON G C/MASCARA	1
35427	MACACAO APIC. NYLON GG C/MASCARA	1



Código	Descrição	Cx.
35498	CANEÇO PARA DERRETER CERA	20



Código	Descrição	Cx.
2238	CENTRIFUGA GALVANIZADA 8 CAX. C/CORREIA	1



Código	Descrição	Cx.
36748	CENTRIFUGA INOX 12 CAX. C/ENGR. ZATTI	1



Código	Descrição	Cx.
2355	CENTRIFUGA INOX 8 CAX. C/CORREIA	1



Código	Descrição	Cx.
24754	CENTRIFUGA INOX 8 CAX. C/ENGR. ZATTI	1



Código	Descrição	Cx.
6367	CENTRIFUGA INOX 16 CAX. C/CORREIA	1



Código	Descrição	Cx.
26843	CENTRIFUGA INOX 16 CAX.C/ENGRENAG.	1



Código	Descrição	Cx.
28447	DECANTADOR P/MEL INOX 80 L	1



BASSO PANCOTTE

Produtos para Agropecuária

Pecuária



Código	Descrição	Cx.
1455	FUMIGADOR PARA APICULTURA	1



Código	Descrição	Cx.
1707	GARFO DESOPERCULADOR CABO PLAST	50



Código	Descrição	Cx.
3829	BUCAL NYLON TERNEIRO C/DEST PRETO	1
3053	BUCAL NYLON TERNEIRO C/DEST VERMELHO	1



Código	Descrição	Cx.
5056	BUCAL NYLON TERNEIRO S/DEST	1



Código	Descrição	Cx.
3826	BUCAL NYLON TOURO C/DESTORCEDOR	1



Código	Descrição	Cx.
3828	BUCAL NYLON VACA C/DESTORCEDOR	1



Código	Descrição	Cx.
5055	BUCAL NYLON VACA S/DESTORCE	1



Código	Descrição	Cx.
29609	FUNIL COADOR BASPAN	50



Código	Descrição	Cx.
29610	PENEIRA COADOR LEITE BASPAN C/5 UNID.	1



Código	Descrição	Cx.
38324	CABO ALCA VASILHAME BASPAN CONJ C/2UNID + 2 PINOS	1



Código	Descrição	Cx.
8356	TAMPA PLAST. P/VASILHAME 30 - 50 L BASPAN	1



Código	Descrição	Cx.
36691	VASILHAME ORDENHA BASPAN 40 L	1



BASSO PANCOTTE

Produtos para Agropecuária

Pecuária



Código	Descrição	Cx.
1608	VASILHAME TRANSPORTE LEITE 30 L BASPAN	1
37376	VASILHAME TRANSPORTE LEITE 50 L BASPAN	1



Código	Descrição	Cx.
28927	EBULIDOR ELETR 127 V 2000 WATS PRATA BRITO	1
28928	EBULIDOR ELETR 220 V 2000 WATS PRATA BRITO	1



Código	Descrição	Cx.
9188	EBULIDOR ELETRICO AGRO 127V FAZEN 2000 W	6
9190	EBULIDOR ELETRICO AGRO 220V FAZEN 2000 W	6



Código	Descrição	Cx.
10864	EBULI ELET AGUA CUR 19cm 127V FAZ 1000 W	24
10865	EBULI ELE AGUA CUR 19cm 220V FAZ 1000 W	24



Código	Descrição	Cx.
10861	EBULIDOR ELETRICO CHIMA 127V FAZ 500 W	12
10860	EBULIDOR ELETRICO CHIMA 220V FAZ 500 W	12



Código	Descrição	Cx.
5385	MEXEDOR DE LEITE INOX	1



Código	Descrição	Cx.
4814	CARRI.FERRO P/TARRO PNEU MACICO	2
2804	RODA CARRINHO TARRO MACICO	50



Código	Descrição	Cx.
2126	BALDE INOX 10 L ORDENHA GRAD. METALOSA	5
2125	BALDE INOX 15 L ORDENHA GRAD. METALOSA	5



Código	Descrição	Cx.
26585	BALDE DE LEITE ALUMINIO 10 L FADELLI	1
26586	BALDE DE LEITE ALUMINIO 15 L FADELLI	1



Código	Descrição	Cx.
22946	TAMPA PLAST. P/VASILHAME 20 LTS UNIPAC	1
22947	TAMPA PLAST. P/VASILHAME 30-40-50 LTS UNIP.	14
22945	TAMPA PLAST. P/VASILHAME 3-5-10 LTS UNIPAC	10



Código	Descrição	Cx.
13668	VASILHAME ORDENHA MILKAN PLUS 40 L	1



Código	Descrição	Cx.
5781	VASILHAME LEITE 3 L	6
5782	VASILHAME LEITE 5 L	6
5783	VASILHAME LEITE 10 L	1
5784	VASILHAME LEITE 20 L	1



BASSO PANCOTTE

Produtos para Agropecuária

Pecuária



Código	Descrição	Cx.
5785	VASILHAME LEITE 30 L TRADICAO (BAIXO)	1



Código	Descrição	Cx.
5788	VASILHAME LEITE 50 L UNIPAC (CINZA ESCURO)	1



Código	Descrição	Cx.
34156	DETECTADOR MASTITE FUNDO PRETO BASPAN	8



Código	Descrição	Cx.
6621	PLACA CMT BASPAN	40



Código	Descrição	Cx.
566	DETECTADOR DE MASTITE C/PENEIRA	1



Código	Descrição	Cx.
6616	CMT TADABRAS SOL. 500 ML	16



Código	Descrição	Cx.
6617	CMT TADABRAS SOL.500 ML C/APLICAD	16



Código	Descrição	Cx.
38164	PAPEL TOALHA C/5 PCT BRANCO 21 x 20 cm	1



Código	Descrição	Cx.
892	IODOPHOR T 1 L 2,5% TADABRAS	12



Código	Descrição	Cx.
6618	TETO-IN TADABRAS 1 L	12
6619	TETO-IN TADABRAS 5 L	4



Código	Descrição	Cx.
6620	TETO-IN TADABRAS 20 L BOMBONA	1



Código	Descrição	Cx.
35655	APLICADOR BASPAN ESPUMA (PRE ORDENHA)	12



BASSO PANCOTTE

Produtos para Agropecuária

Pecuária



Código	Descrição	Cx.
10328	APLICADOR BASPAN S/RETOR. POS ORDENHA	12



Código	Descrição	Cx.
35656	FRASCO P/ APLICADOR IODO BASPAN	18



Código	Descrição	Cx.
28533	APLICADOR IODO SGAMAQ S/RETOR.	12



Código	Descrição	Cx.
2619	APLICADOR IODO C/RETORNO SGAMAC	50



Código	Descrição	Cx.
36832	INSUFLADOR QALYBOR UNIVERIS 1 E 2 ANEL C/4 UN	1



Código	Descrição	Cx.
35287	INSUFLADOR QALYBOR CURTO WF DL C/4 UN	1



Código	Descrição	Cx.
35286	INSUFLADOR QALYBOR UNIVERIS 1 E 2 ANEL C/4 UN	1



Código	Descrição	Cx.
37258	PULSADOR PNEUMATICO QALYPLAST 60X40	1



Código	Descrição	Cx.
539	FUNIL COADOR LEITE BOVITEC	1



Código	Descrição	Cx.
540	PENEIRA COADOR LEITE BOVITEC C/5 UNID.	1



Código	Descrição	Cx.
4151	FUNIL COADOR 12 L. CRISAN	50



Código	Descrição	Cx.
4152	PENEIRA COADOR LEITE CRISAN C/5 UNID.	1



BASSO PANCOTTE

Produtos para Agropecuária

Pecuária



Código	Descrição	Cx.
22951	FUNIL COADOR UNIPAC	1



Código	Descrição	Cx.
22950	PENEIRA PARA COADOR LEITE UNIPAC	1



Código	Descrição	Cx.
3533	ENXOFRE CARTELA GIMARO 6X(7X30G) VENTIL.	1



Código	Descrição	Cx.
32826	OVOFORTE 10X1 KG SUPLEM MINER AVES	1



Código	Descrição	Cx.
27693	BICARBONATO DE SODIO 10 X 1KG (BIOXI)	1



Código	Descrição	Cx.
319	ENXOFRE PECUARIO 10 X 1 KG	1



Código	Descrição	Cx.
28634	SULFATO DE COBRE MOIDO 5 X 1 KG	1



Código	Descrição	Cx.
10565	AGRO TAB TRI 1,4kg (7X200g) CX C/ 15 CLORO	1
10566	AGRO TAB TRI 800g (80X10g) CX C/ 15 CLORO	1



Código	Descrição	Cx.
10536	SANTAB 90 15 X 1,4KG (7 X 200g) CLORO	1
10537	SANTAB 90 15 X 800g (80 X 10g) CLORO	1





GIMACO



Nuctramix

Soluções em Nutrição



SULFATO DE CÔBRE PENTAHIDRATADO
INGREDIENTE MINERAL PARA ALIMENTAÇÃO ANIMAL

BICARBONATO DE SÓDIO
ADITIVO TAMPONANTE PARA ALIMENTAÇÃO ANIMAL

ENXOFRE VENTILADO
INGREDIENTE MINERAL PARA ALIMENTAÇÃO ANIMAL
INDICADO PARA TODAS AS ESPÉCIES

 **Nutract**

 **Nutract**

Lotus:
Data de Fabricação: 180809

PESO LÍQUIDO 1 kg

BRASIL
INSCRIÇÃO
SP-1898
S.I.F.

PESO LÍQUIDO 1 kg

FRACIONADO POR:
NUTRACT AGROINDUSTRIAL LTDA.

Rua Inocência de Sousa Branco, 81-E | Bairro Quedas do Palmital | Campinas - SP

Cnpj: 06.15-319 | Fone: (49) 3323-1111 | Fax: 3329-1112

CNPJ: 01.855.831/0001-21 | I.E.: 53.903.088

e-mail: nutract@nutract.com.br | www.nutract.com.br

ATENÇÃO AO CONSUMIDOR: 3329-1111

Produto sujeito de registro no Ministério da Agricultura

Pecuária e Abastecimento

Produto registrado no Ministério da Agricultura

Pecuária e Abastecimento

Produto registrado no Ministério da Agricultura

Pecuária e Abastecimento

Produto registrado no Ministério da Agricultura

Pecuária e Abastecimento

Produto registrado no Ministério da Agricultura

Pecuária e Abastecimento

**BASSO PANCOTTE**

Produtos para Agropecuária

Equipamentos veterinários

Código	Descrição	Cx.
6476	AGULHA SUTURA CILINDRICA GR-06 C/12UN. (1/2x1,2mmx55mm)	1



Código	Descrição	Cx.
6467	AGULHA TRIAN B-01 C/12UN (3/8x1,4mmx80mm)	1
6468	AGULHA TRIAN B-02 C/12UN (3/8x1,4mmx75mm)	10
6471	AGULHA TRIAN B-11 C/12UN (3/8x0,8mmx32mm)	1
6470	AGULHA TRIAN B-14 C/12UN (3/8x0,6mmx22mm)	1



Código	Descrição	Cx.
28299	AGULHA VETERIN. 4 X 0.8 TUBERCULINA WALMUR C/12 UNID	1

Código	Descrição	Cx.
37707	AGULHA HOPPNER 100 X10 HIPODERMICA C/12	1
3347	AGULHA HOPPNER 100 X20 HIPODERMICA C/12	1
6041	AGULHA HOPPNER 10 X08 HIPODERMICA C/12	1
6027	AGULHA HOPPNER 10 X10 HIPODERMICA C/12	1
6025	AGULHA HOPPNER 10 X12 HIPODERMICA C/12	1
6033	AGULHA HOPPNER 10 X15 HIPODERMICA C/12	1
6030	AGULHA HOPPNER 10 X18 HIPODERMICA C/12	1
24625	AGULHA HOPPNER 12 X08 HIPODERMICA C/12	1
6042	AGULHA HOPPNER 12 X10 HIPODERMICA C/12	1
6593	AGULHA HOPPNER 12 X15 HIPODERMICA C/12	1
6023	AGULHA HOPPNER 12 X18 HIPODERMICA C/12	1
24710	AGULHA HOPPNER 15 X08 HIPODERMICA C/12	1
6021	AGULHA HOPPNER 15 X10 HIPODERMICA C/12	1
25086	AGULHA HOPPNER 15 X12 HIPODERMICA C/12	1
6020	AGULHA HOPPNER 15 X15 HIPODERMICA C/12	1
6038	AGULHA HOPPNER 15 X18 HIPODERMICA C/12	1
6031	AGULHA HOPPNER 15 X20 HIPODERMICA C/12	1
6029	AGULHA HOPPNER 20 X 10 HIPODERMICA C/12	1

Código	Descrição	Cx.
6036	AGULHA HOPPNER 20 X12 HIPODERMICA C/12	1
6034	AGULHA HOPPNER 20 X15 HIPODERMICA C/12	1
6037	AGULHA HOPPNER 20 X18 HIPODERMICA C/12	1
6043	AGULHA HOPPNER 20 X20 HIPODERMICA C/12	1
22964	AGULHA HOPPNER 25 X10 HIPODERMICA C/12	1
6022	AGULHA HOPPNER 25 X12 HIPODERMICA C/12	1
6032	AGULHA HOPPNER 25 X15 HIPODERMICA C/12	1
6040	AGULHA HOPPNER 25 X18 HIPODERMICA C/12	1
25915	AGULHA HOPPNER 30 X10 HIPODERMICA C/12	1
25916	AGULHA HOPPNER 30 X12 HIPODERMICA C/12	1
6024	AGULHA HOPPNER 30 X 15 HIPODERMICA C/12	1
6035	AGULHA HOPPNER 30 X18 HIPODERMICA C/12	1
6594	AGULHA HOPPNER 35 X15 HIPODERMICA C/12	1
25473	AGULHA HOPPNER 40 X12 HIPODERMICA C/12	1
6039	AGULHA HOPPNER 40 X15 HIPODERMICA C/12	1
6028	AGULHA HOPPNER 40 X18 HIPODERMICA C/12	1
6026	AGULHA HOPPNER 40 X20 HIPODERMICA C/12	1



Código	Descrição	Cx.
4125	APLICADOR UNIV INOX P/INSEM ARTIFIC	1



Código	Descrição	Cx.
5921	AGULHA VETERIN. 10 X 10 C/12 UNID.	1
5922	AGULHA VETERIN. 10 X 12 C/12 UNID.	1
5923	AGULHA VETERIN. 10 X 15 C/12 UNID.	1
5924	AGULHA VETERIN. 10 X 18 C/12 UNID.	1
24624	AGULHA VETERIN. 12 X 15 C/12 UNID.	1
5929	AGULHA VETERIN. 12 X 18 C/12 UNID.	1
12294	AGULHA VETERIN. 12 X 20 C/12 UNID.	1

Código	Descrição	Cx.
4279	AGULHA VETERIN. 15 X 12 C/12 UNID.	1
1381	AGULHA VETERIN. 15 X 15 C/12 UNID.	1
5927	AGULHA VETERIN. 15 X 18 C/12 UNID.	1
5928	AGULHA VETERIN. 15 X 20 C/12 UNID.	1
5940	AGULHA VETERIN. 18 X 20 C/12 UNID.	1
23316	AGULHA VETERIN. 20 X 10 C/12 UNID.	1
5930	AGULHA VETERIN. 20 X 12 C/12 UNID.	1
5931	AGULHA VETERIN. 20 X 15 C/12 UNID.	1
5932	AGULHA VETERIN. 20 X 18 C/12 UNID.	1
5933	AGULHA VETERIN. 20 X 20 C/12 UNID.	1
5934	AGULHA VETERIN. 25 X 10 C/12 UNID.	1
5935	AGULHA VETERIN. 25 X 12 C/12 UNID.	1
5936	AGULHA VETERIN. 25 X 15 C/12 UNID.	1
5937	AGULHA VETERIN. 25 X 18 C/12 UNID.	1
906	AGULHA VETERIN. 30 X 15 C/12 UNID.	1
5944	AGULHA VETERIN. 40 X 15 C/12 UNID.	1
5945	AGULHA VETERIN. 40 X 18 C/12 UNID.	1
32974	AGULHA VETERIN. 40 X 20 C/12 UNID.	1



Código	Descrição	Cx.
31990	BAINHA INSEMIN ARTIFIC.C/50 UND FRANCESA	20



Código	Descrição	Cx.
1491	PIPETA DESC P/LAV UTERINA PC/25UN	50



Código	Descrição	Cx.
24126	LUVA DESC 5 D IMP. C/100 ESPECIALFLEX 80cm CX AZUL	10



BASSO PANCOTTE

Produtos para Agropecuária

Agulhas em tamanho real



32970 - Agulha 10 x 8



5923 - Agulha 10 x 15



5921 - Agulha 10 x 10



5924 - Agulha 10 x 18



5922 - Agulha 10 x 12



5925 - Agulha 10 x 20



5926 - Agulha 15 x 8



1381 - Agulha 15 x 15



1853 - Agulha 15 x 10



5927 - Agulha 15 x 18



4279 - Agulha 15 x 12



5928 - Agulha 15 x 20



32971 - Agulha 12 x 8



24624 - Agulha 12 x 15



32972 - Agulha 12 x 10



5929 - Agulha 12 x 18



27652 - Agulha 12 x 12



24622 - Agulha 18 x 18



5940 - Agulha 18 x 20



23316 - Agulha 20 x 10



5934 - Agulha 25 x 10



5939 - Agulha 30 x 10



5930 - Agulha 20 x 12



5935 - Agulha 25 x 12



27653 - Agulha 30 x 12



5931 - Agulha 20 x 15



5936 - Agulha 25 x 15



906 - Agulha 30 x 15



5932 - Agulha 20 x 18



5937 - Agulha 25 x 18



5941 - Agulha 30 x 18



5933 - Agulha 20 x 20



32973 - Agulha 25 x 20



5942 - Agulha 30 x 20



5943 - Agulha 40 x 12



5945 - Agulha 40 x 18



5944 - Agulha 40 x 15



32974 - Agulha 40 x 20



BASSO PANCOTTE

Produtos para Agropecuária

Equipamentos veterinários



Código	Descrição	Cx.
25218	LUVA DESC 5 D COMUM BP C/100 UN	25



Código	Descrição	Cx.
23676	LUVA DESC 5 D ESP C/100 BP EVA CANO LONGO	25



Código	Descrição	Cx.
36904	LUVA DESC 5 D SUPERSENSITIVAS 5D 90CM R6952	10



Código	Descrição	Cx.
913	LUVA DESC 5 D COMUM BP C/25 UN	50



Código	Descrição	Cx.
4410	LUVA DESC 5 D NACIONAL C/25 BP EVA	50



Código	Descrição	Cx.
31655	LUVA DESC INSEM NECK C/50UN (OMBRO)	1



Código	Descrição	Cx.
3126	LUVA CIRURGICA ESTERIL 6,5 SUPERMAX	1
3127	LUVA CIRURGICA ESTERIL 7,0 SUPERMAX	200
1551	LUVA CIRURGICA ESTERIL 7,5 SUPERMAX	1
3128	LUVA CIRURGICA ESTERIL 8,0 SUPERMAX	200
38127	LUVA CIRURGICA ESTERIL 8,5 SUPERMAX	1



Código	Descrição	Cx.
599	DOSADORA DE BOLA FC 60 ML	50



Código	Descrição	Cx.
23926	GANCHO DOSIFICADOR 80CM WALMUR COD.32	1



Código	Descrição	Cx.
2965	BICO DOSIFICADOR (ELIO FERNANDES)	24



Código	Descrição	Cx.
1111	BICO DOSADOR INCOMAVE 165 ML	1



Código	Descrição	Cx.
69	BICO DOSADOR WALMUR	1



BASSO PANCOTTE

Produtos para Agropecuária

Equipamentos veterinários



Código	Descrição	Cx.
28094	DEPOSITO WALMUR 2 LTS P/DOSAD. E PULV REF. 1002	2



Código	Descrição	Cx.
35794	DEPOSITO WALMUR 5 LTS P/DOSAD. E PULV REF. 34	1



Código	Descrição	Cx.
24708	ESPARADRAPO MISSNER 10 X 4,5	24



Código	Descrição	Cx.
37915	CABO DE BISTURI INOX N.4 ABC	1



Código	Descrição	Cx.
37913	PINCA ANATOMICA DENTE DE RATO 20CM ABC	1



Código	Descrição	Cx.
37916	PINCA ANATOMICA DISSECCAO 16CM ABC	1
37914	PINCA ANATOMICA DISSECCAO 20CM ABC	1



Código	Descrição	Cx.
10530	PINÇA FOERSTER 24 CM RETA C/SERRILHA	1



Código	Descrição	Cx.
38251	PINÇA HALSTEAD MOSQUITO CURVA 12CM ABC	1



Código	Descrição	Cx.
37912	PINÇA HALSTEAD MOSQUITO RETA 12CM ABC	1



Código	Descrição	Cx.
38264	PINÇA KELLY CURVA 16CM ABC	1
37895	PINÇA KELLY CURVA 18CM ABC	1



Código	Descrição	Cx.
37911	PINÇA KELLY RETA 16CM ABC	1
37896	PINÇA KELLY RETA 18CM ABC	1



Código	Descrição	Cx.
37909	PORTA AGULHA MATHIEU 17CM ABC	1
38252	PORTA AGULHA MATHIEU 20CM ABC	1



BASSO PANCOTTE

Produtos para Agropecuária

Equipamentos veterinários



Código	Descrição	Cx.
37894	PORTA AGULHA MAYO HEGAR 16 CM ABC	1



Código	Descrição	Cx.
38262	TESOURA CIR 17CM CURVA ROMBA/ROMBA ABC	1



Código	Descrição	Cx.
37907	TESOURA CIRURGICA 17CM RETA FINA/ROMBA ABC	1



Código	Descrição	Cx.
38263	TESOURA CIR 17CM RETA ROMBA/ROMBA ABC	1



Código	Descrição	Cx.
37908	TESOURA CIRURGICA 17CM RETA FINA/FINA ABC	1



Código	Descrição	Cx.
33584	TES CIR MAYO-STILLE CURVA ROM-ROMB 19CM BASPAN	1



Código	Descrição	Cx.
25048	ADAPTADOR P/AGU VACUTAINER BD C/10 UNID	1



Código	Descrição	Cx.
29270	CATETER ITRAV DESC. 20G 1.16 ANGIOCATH BD	1
29271	CATETER ITRAV DESC. 22G 1.00 ANGIOCATH BD	1



Código	Descrição	Cx.
9785	LAMINA BISTURI N°24 AÇO CARB. CIRUBLADE C/100 UN.	50



Código	Descrição	Cx.
2277	CATETER ITRAV DESC. 24G 0,75 ANGIOCATH BD	1



Código	Descrição	Cx.
36651	SCALP 21G ASEPTO BD	1
36652	SCALP 23G ASEPTO BD	1
36653	SCALP 25G ASEPTO BD	1



Código	Descrição	Cx.
26468	TUBO COL.SANGUE 4ML C/100 T.VERMELHA	10
22740	TUBO COL.SANGUE 10MLC/100 T.VERMELHA	10



BASSO PANCOTTE

Produtos para Agropecuária

Equipamentos veterinários



Código	Descrição	Cx.
26533	BOLSA COLETA SANGUE 500 ML	50



Código	Descrição	Cx.
9020	EQUIPO MACRO LAMEDID CONEC Y MOD. 24	500



Código	Descrição	Cx.
9019	SERINGA INSULINA 01 ML (13 X 4,5) c/100 unid SOLIDOR	20



Código	Descrição	Cx.
22725	ATADURA CREPE 10 CM X 1,20 M C/12 UNID	1
35534	ATADURA CREPE 12 CM X 1,20 M C/12 UNID	1
22726	ATADURA CREPE 15 CM X 1,20 M C/12 UNID	1
4015	ATADURA CREPE 15 CM X 1,80 M C/12 UNID	1



Código	Descrição	Cx.
25673	CAMPO OPERATORIO 23X25 C/50 UN	1



Código	Descrição	Cx.
25672	CAMPO OPERATORIO 45X50 C/50 UN	1



Código	Descrição	Cx.
22728	COMPRESSA GAZE 7,5x7,5 PC C/500 (09 fios) JASMIM	1



Código	Descrição	Cx.
32331	COMPRESSA GAZE 7,5x7,5 PC C/500 (11 fios) TULIPA	1



Código	Descrição	Cx.
31522	COMPRESSA GAZE 7,5x7,5 PC C/500 (13 FIOS) VIOLETA	1



Código	Descrição	Cx.
22732	ALGODAO HIDROF 500GR(ROLO)	20



Código	Descrição	Cx.
37978	ESTETOSCOPIO RAPPAPORT DUPLO REF 29858.08 INCOT	1



Código	Descrição	Cx.
24471	CASTRADOR CHIFA 19" IMPORTADO MD. BURDIZO	1



BASSO PANCOTTE

Produtos para Agropecuária

Equipamentos veterinários



Código	Descrição	Cx.
38157	EQUIPO MACRO. FILTRO C/AG 40x16 MEDPLAST	250



Código	Descrição	Cx.
38156	EQUIPO MACRO. FILTRO C/INJETOR LATERAL MEDPLAST	250



Código	Descrição	Cx.
38155	EQUIPO MACRO. FILTRO C/PINÇA ROL. MEDPLAST	250



Código	Descrição	Cx.
1192	ABRE BOCA P/ BOI E CAVALOS	1



Código	Descrição	Cx.
6151	AGULHA SUTURA EM S 11 CM C/3 UNID. PACOTE COD.555	1



Código	Descrição	Cx.
2678	SONDA ESOFAGICA THYGESSEN	1



Código	Descrição	Cx.
31575	CUTIMETRO WALMUR INOX ANALOG CÓD.2860	1



Código	Descrição	Cx.
10570	FORCEPS VET. WALMUR C/ CREMALHEIRA	1



Código	Descrição	Cx.
24792	SONDA MAMARIA C/ ADAP 45 MM COD.89 WALMUR	1



Código	Descrição	Cx.
24752	SONDA MAMARIA C/ ADAP 60 MM COD.88 WALMUR	1



Código	Descrição	Cx.
29625	SONDA MAMARIA DESCART. C/10 UNID REF	1



Código	Descrição	Cx.
914	SONDA MAMARIA C/ ADAP 60 MM COD.88 WALMUR	1



BASSO PANCOTTE

Produtos para Agropecuária

Equipamentos veterinários



Código	Descrição	Cx.
633	TROCATER DIAM. 6 MM COMP. 11 CM	1
4788	TROCATER DIAM. 10 MM COMP. 15 CM	1



Código	Descrição	Cx.
38346	CATGUT CROMADO No. 0 C/AG CX.24 SHALON	1
1507	CATGUT CROMADO No. 0 S/AG CX.24 SHALON	1
1492	CATGUT CROMADO No. 1 C/AG CX.24 SHALON	1
693	CATGUT CROM No 2 S/AG -1,5M CX.24 SHALON	1
38471	CATGUT CROMADO No 2-0 C/AG CX.24 SHALON	1
38058	CATGUT CROMA No 3 S/AG -1,5M CX.12 SHALON	1
38345	CATGUT CROMADO No. 3-0 C/AG CX.24 SHALON	1
38059	CATGUT CROM No. 4 S/AG -1,5M CX.12 SHALON	1



Código	Descrição	Cx.
4494	CATGUT SIMPLES N 0 S/AG -1,5M CX24 SHALON	1
4495	CATGUT SIMPLES N 1 S/AG -1,5M CX24 SHALON	1
4481	CATGUT SIMPLES N 2 S/AG -1,5M CX.24 SHALON	1
4487	CATGUT SIMPLES N 3 S/AG -1,5M CX.12 SHALON	1
4496	CATGUT SIMPLES N 4 S/AG -1,5M CX.12 SHALON	1



Código	Descrição	Cx.
4278	PIPETA SERVI LAV.UTERINA 50CM METALICA	20



Código	Descrição	Cx.
38347	NYLON PRETO No 2-0 C/AG 0 CX.24 SHALON	1
38053	NYLON PRETO No 2-0 S/AG 1,5m CX.24 SHALON	1
38056	NYLON PRETO No 3-0 C/AG 2CTI CX.24 SHALON	1
38055	NYLON PRETO No 0 C/AG 2CTI CX.24 SHALON	1
38054	NYLON PRETO No 0 S/AG 1,5m CX.24 SHALON	1



Código	Descrição	Cx.
37647	OLEO LUBRIF. P/ SERINGAS 30 ml C/4 UNID.	1



Código	Descrição	Cx.
33772	ANEL BOR. PISTOLA BASPAN HSW 50ML C/2 UN	1



Código	Descrição	Cx.
33767	ANEL BOR. VACINA BASPAN HSW 0,3ML C/2 UN	1
33770	ANEL BOR. VACINA BASPAN HSW 5ML C/2 UN	1



Código	Descrição	Cx.
38136	CESTA P/VACINADOR BASPAN FRASCO 250ml	1



Código	Descrição	Cx.
33779	CORPO PLAST PISTOLA BASPAN HSW 50 ML	1



Código	Descrição	Cx.
4374	AGULHA COLETA SANGUE 25X08 C/100 UNID. CAIXA (360212)	10



BASSO PANCOTTE

Produtos para Agropecuária

Equipamentos veterinários



Código	Descrição	Cx.
3853	EIXO INTERNO P/SER. WALMUR 50 CC	10



Código	Descrição	Cx.
23187	EIXO INTERNO INCOMAVE 25 CC	1



Código	Descrição	Cx.
2884	JOGO BORR. TIPO HOPPNER 25CC C/5 UNID.	5
2885	JOGO BORR. TIPO HOPPNER 50CC C/5 UNID.	1



Código	Descrição	Cx.
744	JOGO BORR. TIPO INCOMAVE 50CC. C/5 UNID.	1
743	JOGO BORR. TIPO INCOMAVE 25CC C/5 UNID.	1



Código	Descrição	Cx.
24929	JOGO BORR. TIPO INCOMAVE 30CC C/5 UNID.	5



Código	Descrição	Cx.
24725	JOGO BORR. TIPO SERVI 25CC C/5 UNID.	5
24727	JOGO BORR. TIPO SERVI 50CC C/5 UNID.	1



Código	Descrição	Cx.
751	JOGO BORR. TIPO WALMUR 25 CC C/5 UNID	1
752	JOGO BORR. TIPO WALMUR 50 CC C/5 UNID.	1



Código	Descrição	Cx.
2767	ANEL VEDACAO SERI. FAZFORTE C/10 UNID. PACOTE	1



Código	Descrição	Cx.
26869	VIDRO SERINGA TIPO HOPPANTIGO 50 CC C.H.FOSTER	25



Código	Descrição	Cx.
4671	VIDRO SERINGA TIPO FC 50 CC (PISTOLA)	5



Código	Descrição	Cx.
24927	VIDRO SERINGA TIPO HOPPNER 30CC	5
2882	VIDRO SERINGA TIPO HOPPNER 50CC	25



Código	Descrição	Cx.
745	VIDRO SERINGA TIPO INCOMAVE 25 CC	1
24926	VIDRO SERINGA TIPO INCOMAVE 30 CC	25
746	VIDRO SERINGA TIPO INCOMAVE 50 CC	25



BASSO PANCOTTE

Produtos para Agropecuária

Equipamentos veterinários



Código	Descrição	Cx.
753	VIDRO SERINGA TIPO WALMUR 25 CC	1
754	VIDRO SERINGA TIPO WALMUR 50 CC	25



Código	Descrição	Cx.
24723	VIDRO SERINGA TIPO SERVI 50CC	1



Código	Descrição	Cx.
10256	TUBO EXTERNO (CORPO) PISTOLA BASPAN C/1 UNI	1



Código	Descrição	Cx.
10376	TUBO INTERNO (VIDRO) PISTOLA BASPAN C/1 UN	1



Código	Descrição	Cx.
25294	TUBO SERI.PLAST. 50 ML Y-01 C/1 UNID. INCOMAVE	1



Código	Descrição	Cx.
4342	CORPO NO 3 SERVI C/2 UNID.SERVI	5



Código	Descrição	Cx.
38165	TUBO DE VIDRO DOSAD. 20CC cod 868	1



Código	Descrição	Cx.
10791	TUBO PROTETOR DOSADORA 20 ML WALMUR	1



Código	Descrição	Cx.
38062	BOTAO GRAD. EMBOLO 7130 PISTOLA 3000 WALMUR	1



Código	Descrição	Cx.
4063	BASE DO ADAPTADOR R.20 C/1 UNID WALMUR	1



Código	Descrição	Cx.
22687	BOLA BORRACHA FC DOSAD 60 ML C/1 UNID	1



Código	Descrição	Cx.
24751	BOTAO GRAD. EMBOLO R.15 C/1 UNID. WALMUR	1



BASSO PANCOTTE

Produtos para Agropecuária

Equipamentos veterinários



Código	Descrição	Cx.
4073	HASTE EMBOALO R.17 P/PISTOLA MOD 50CC /91/W50	1



Código	Descrição	Cx.
32231	BARRA DOSADORA P/SERINGA TUBERCULINA	1



Código	Descrição	Cx.
25259	TACA SER.25 ML PLASTICA Z-02 INCOMAVE C/1 UNID.	1



Código	Descrição	Cx.
32226	EXTENSAO P/SERINGA E VACINADOR SERVI	1



Código	Descrição	Cx.
24486	VIDRO SERINGA TUBERCULINA 2 ML COD.259 WALMUR	1 25



Código	Descrição	Cx.
37831	EMPUNHADURA FIXA TUBERCULINA	1



Código	Descrição	Cx.
28300	JOGO BORR. SER TUBERCULINA cod.261 WALMUR	1



Código	Descrição	Cx.
4340	PUNHO NO 1 PISTOLA SERVI	5



Código	Descrição	Cx.
4367	REGULADOR DOSAG.COMPLETO NO 28 C/2 UNID. SERVI	2



Código	Descrição	Cx.
32914	JOGO DE BORRACHAS DOS.20 CC WALMUR COD.879	1



Código	Descrição	Cx.
37824	PONTEIRA AMERIC.P/TUBERCULINA Cod.263	1



Código	Descrição	Cx.
34940	MOLA DA EMPUNHAD R.12 7902 PISTOLA 3000 C/1 UNID	1



A Fazfort possui mais de 30 anos de experiência em plástico injetado para o mercado do agronegócio.





BASSO PANCOTTE

Produtos para Agropecuária

Equipamentos veterinários



Código	Descrição	Cx.
12529	EXTENSOR DE INJEÇÃO INTRA MUSCULAR SIMCRO	1



Código	Descrição	Cx.
12073	KIT REPARO SERINGA PREMIUM 02 ML SIMCRO	1



Código	Descrição	Cx.
12077	KIT REPARO SERINGA PREMIUM 06 ML SIMCRO	1



Código	Descrição	Cx.
12068	KIT REPARO SERINGA PREMIUM 12 ML SIMCRO	1



Código	Descrição	Cx.
12072	KIT REPARO SERINGA ACCURUS 06 ML SIMCRO	1
12074	KIT REPARO SERINGA ACCURUS 12 ML SIMCRO	1



Código	Descrição	Cx.
12071	KIT REPARO SERINGA OPTIMIZER 12,5 ML SIMCRO (outras)	1



Código	Descrição	Cx.
12079	KIT REPARO SERINGAS FRASCO ACOPLADO SIMCRO	1

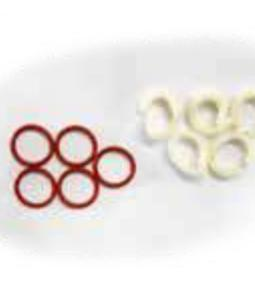

Código	Descrição	Cx.
12070	KIT REPARO SERINGA OPTIMIZER 12,5 ML SIMCRO (anéis)	1



Código	Descrição	Cx.
12078	KIT REPARO SERINGAS FLUXO CONTINUO SIMCRO	1



Código	Descrição	Cx.
12076	KIT REPARO APLICADOR ORAL 20 ML SIMCRO	1



Código	Descrição	Cx.
12075	KIT REPARO APLICADOR POUR-ON 30 ML SIMCRO	1



BASSO PANCOTTE

Produtos para Agropecuária

Equipamentos veterinários



Código	Descrição	Cx.
9064	KIT REPARO BARRIL 50ml SIMCRO	1



Código	Descrição	Cx.
9062	KIT REPARO ANEL O RING 25ml SIMCRO	1
9061	KIT REPARO ANEL O RING 50ml SIMCRO	1



Código	Descrição	Cx.
37183	SERINGA DESC B.D. 3ML C/AG C/RLOCK AG.25X7	150



Código	Descrição	Cx.
912	SERINGA DESC B.D. 5 ML S/AG LUER-LOK (990175)	700

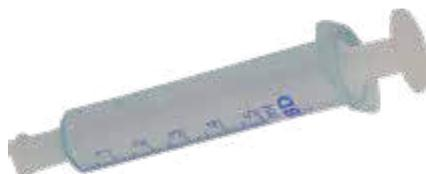

Código	Descrição	Cx.
22736	SERINGA DESC B.D. HOSP.5ML C/20 UN ORALPAK (990092)	1



Código	Descrição	Cx.
6434	SERINGA DESC B.D. 5 ML C/AG AG.25X7 (990628)	700



Código	Descrição	Cx.
6387	SERINGA DESC. B.D.10 ML S/AG C/ROSCA LOCK (990172)	1



Código	Descrição	Cx.
3284	SERINGA DESC. B.D.20 ML S/AG UNAPLIC (990173)	250



Código	Descrição	Cx.
6388	SERINGA DESC. B.D.10 ML C/AG AG.25X7 LOCK (990629)	400



Código	Descrição	Cx.
12204	SERINGA SEM AGULHA LUER LOCK 60 ML DESCARPACK	300



Código	Descrição	Cx.
11579	AGULHA DESCARTÁVEL 25 X 07 C/100	100
11580	AGULHA DESCARTÁVEL 25 X 08 C/100	100
11581	AGULHA DESCARTÁVEL 40 X 12 C/100	100



BASSO PANCOTTE

Produtos para Agropecuária

Equipamentos veterinários



Código	Descrição	Cx.
11042	SERINGA DESC 10 ML C/AG 25 X 07 LOCK SR	250
11043	SERINGA DESC 5 ML C/AG 25 X 07 LOCK SR	500



Código	Descrição	Cx.
11578	SERINGA SEM AGULHA SLIP 60 ML DESCARPACK	300



Código	Descrição	Cx.
11041	SERINGA DESC LUER LOOK 20 ML S/AG RYMCO	1



Código	Descrição	Cx.
12463	SERINGA DESC. 3ML C/AG 25X7 ROSCA C/100 UN RYNCO	18



Código	Descrição	Cx.
2886	AGULHA DESC 25 X 07 B.D. C/100 UN	10
4195	AGULHA DESC 25 X 08 B.D. C/100 UN	10
5430	AGULHA DESC 25 X 10 B.D. C/100 UN	10
6389	AGULHA DESC 40 X 12 B.D. C/100 UN	10
3283	AGULHA DESC 40 X 16 B.D. C/100 UN	10



Código	Descrição	Cx.
29538	SERINGA WALMUR DOS AUT. VIDRO PLAST	1
28093	SERINGA WALMUR DOS AUT. VIDRO METAL	1



Código	Descrição	Cx.
4280	SERINGA METALICA VET. SERVI 25 CC	10
4282	SERINGA METALICA VET. SERVI 50 CC SIMPLES	12



Código	Descrição	Cx.
1696	SERINGA FAZFORT 25ML	1



Código	Descrição	Cx.
10069	SERINGA 25 ML PLASTICA VERDE	200



Código	Descrição	Cx.
7474	SERINGA 0,5 ML CIRCOVAC C/MANGUEIRA	1



Código	Descrição	Cx.
31703	SERINGA FAZFORT 25ML KIT + 2 AGU + 4 ANEIS	1



BASSO PANCOTTE

Produtos para Agropecuária

Equipamentos veterinários



Código	Descrição	Cx.
360	SERINGA INCOMAVE 25CC LARANJA PLASTICA	1



Código	Descrição	Cx.
26647	SERINGA WALMUR 25 CC PLASTICA R.1506	1



Código	Descrição	Cx.
742	SERINGA INCOMAVE 25 CC METALICA	1



Código	Descrição	Cx.
37304	SERINGA VETERINARIA 25ML TB SGAMAQ	20



Código	Descrição	Cx.
33103	SERINGA 0,5 ML CIRCOVAC	1



Código	Descrição	Cx.
33766	VACINADOR BASPAN HSW 0,3 ML	25



Código	Descrição	Cx.
6044	PISTOLA AUT. HOPPNER 50 CC -BLISTER	10



Código	Descrição	Cx.
10708	PISTOLA AUT. SGAMAQ CABO "PLASTICA" 50 CC	10



Código	Descrição	Cx.
24760	PISTOLA AUT. INCOMAVE "PLASTICA" 50 CC	1



Código	Descrição	Cx.
249	PISTOLA AUT. WALMUR C.ABERTO 50 CC REF 0056	1



Código	Descrição	Cx.
5437	PISTOLA AUT.SERVI 50ML P.FECHADO (S/ ACCESORIOS)	24



Código	Descrição	Cx.
33778	PISTOLA BASPAN HSW 50 ML SUPRA	1



BASSO PANCOTTE

Produtos para Agropecuária

Equipamentos veterinários



Código	Descrição	Cx.
6851	PISTOLA AUT. 50CC C.FECHADO BASPAN	1



Código	Descrição	Cx.
717	PISTOLA AUT. INCOMAVE METALICA 50CC	1



Código	Descrição	Cx.
9067	SERINGA PREMIUM 2ML FRASCO ACOPLADO SIMCRO	1



Código	Descrição	Cx.
10869	SERINGA PREMIUM 6 ML FRASCO ACOPLADO SIMCRO	1



Código	Descrição	Cx.
9071	SERINGA ACCURUS 6ml FRASCO ACOPLADO SIMCRO	1



Código	Descrição	Cx.
9070	SERINGA ACCURUS 12ml FLUXO CONTINUO SIMCRO	1



Código	Descrição	Cx.
9069	APLICADOR ORAL 20ml DOSES VARIÁVEIS	1 1



Código	Descrição	Cx.
9066	SERINGA OPTIMISER 12 ML FLUXO CONTINUO (kit 3 em 1) SIMCRO	1



Código	Descrição	Cx.
9068	APLICADOR POUR ON 30ml FLUXO CONTINUO	1



Código	Descrição	Cx.
9072	SERINGA PREMIUM 12ml FLUXO CONTINUO SIMCRO	1



Código	Descrição	Cx.
9058	SERINGA METALICA SEMI AUTOMATICA 50ml SIMCRO	1



Código	Descrição	Cx.
9060	SERINGA SEMI AUTOMATICA 25ml SIMCRO	1
9059	SERINGA SEMI AUTOMATICA 50ml SIMCRO	1



BASSO PANCOTTE

Produtos para Agropecuária

Equipamentos veterinários

PISTOLA AUTOMÁTICA INCOPELA METÁLICA 50 CC

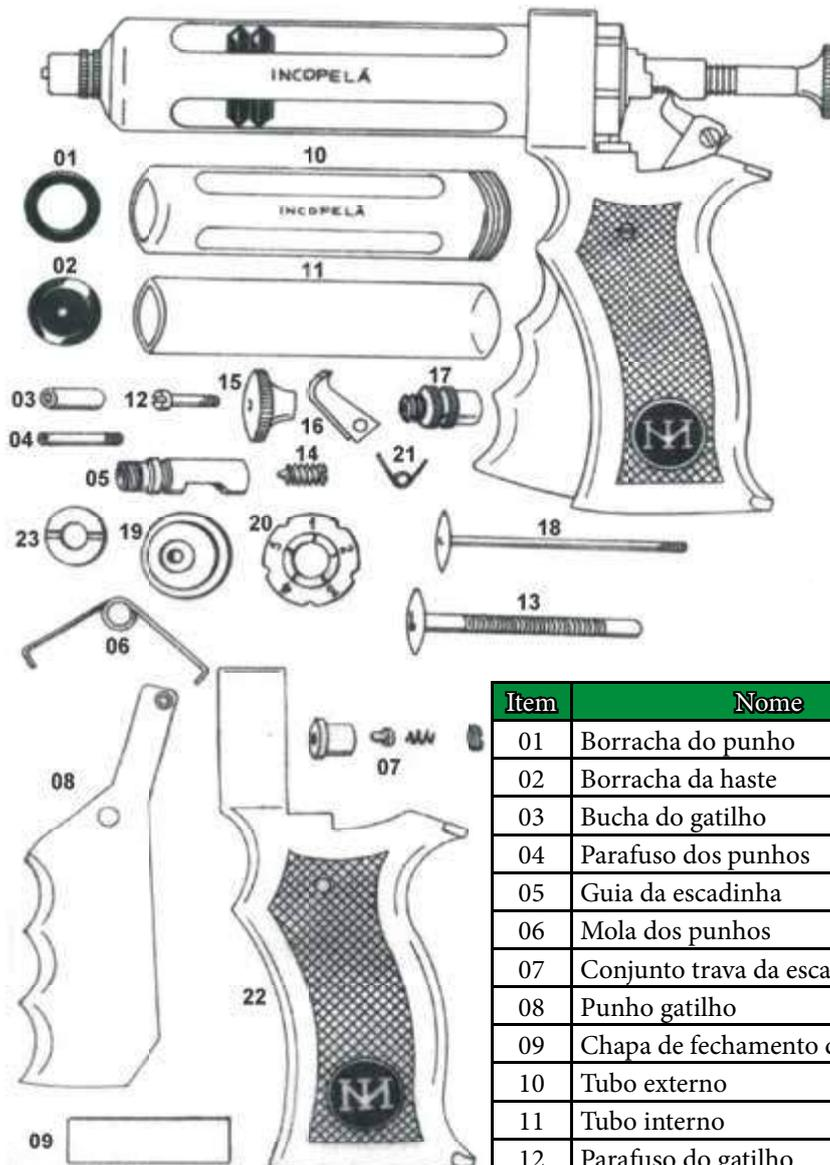

Item	Nome	Código
01	Borracha do punho	744
02	Borracha da haste	744
03	Bucha do gatilho	24427
04	Parafuso dos punhos	24428
05	Guia da escadinha	24429
06	Mola dos punhos	24430
07	Conjunto trava da escadinha	24431
08	Punho gatilho	24432
09	Chapa de fechamento dos punhos	24433
10	Tubo externo	24434
11	Tubo interno	746
12	Parafuso do gatilho	24435
13	Tubo graduado	24436
14	Parafuso da escadinha	24437
15	Porca da haste	24438
16	Gatilho	24439
17	Bico	24440
18	Haste, eixo interno	24441
19	Pastilha	24442
20	Escadinha	24443
21	Mola do gatilho	24444
22	Punho	24445
23	Porca da guia da escadinha	24446



BASSO PANCOTTE

Produtos para Agropecuária

Equipamentos veterinários

PISTOLA AUT. WALMUR C. ABERTO 50 cc REF. 0056

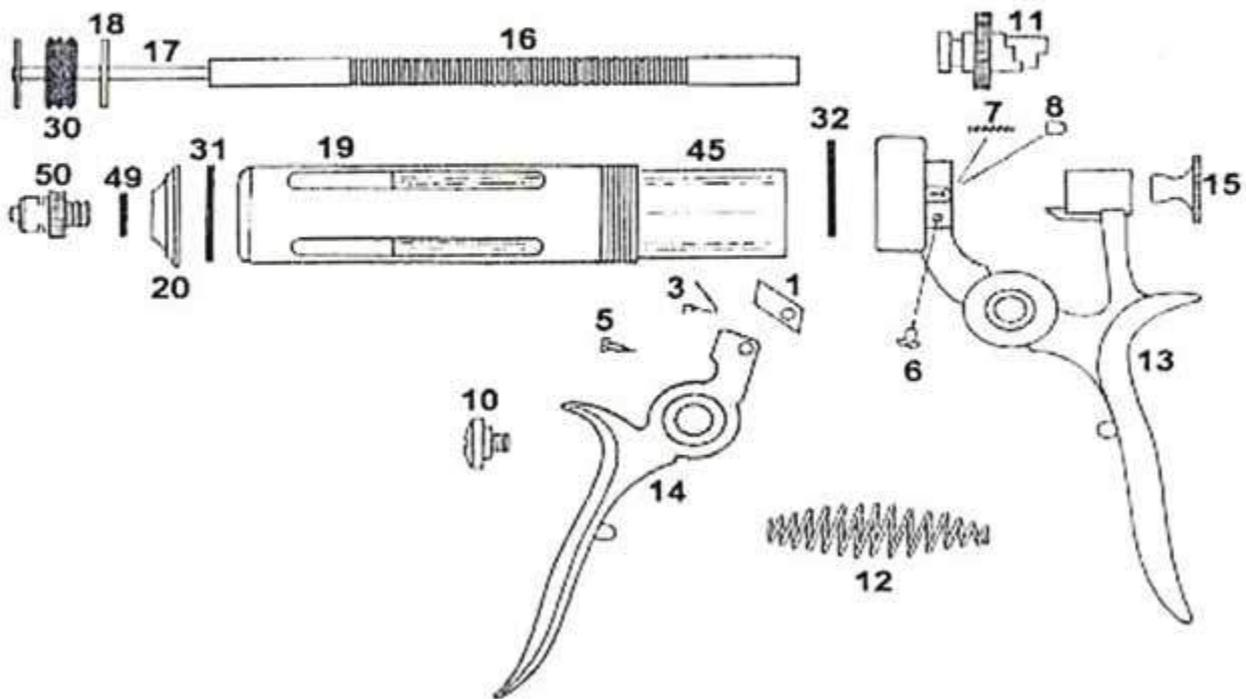

Item	Nome	Código
1	Lingueta pistola c/1 un.	2506
3	Mola lingueta pistola c/1 un.	5844
5	Eixo lingueta pistola c/1 un.	1633
6	Parafuso da peça reguladora c/1 un.	22706
7	Mola da trava	22707
8	Trava da peça reguladora	22708
10	Eixo da empunhadura	3955
11	Peça reguladora de doses c/1 un.	3956
12	Mola da empunhadura c/1 un.	3957
13	Empunha. fixa c/1 un.	3958

Item	Nome	Código
14	Empunhadura movel c/1 un.	3959
15	Botão grad. embolo c/1 un.	24751
16	Barra dosadora	27356
17	Eixo interno	3853
18	Arruela metal c/3 un.	4061
19	Tubo protetor c/1 un.	4062
20	Base do adaptador c/1 un.	4063
45	Tubo de vidro	3945
50	Ponteira americana c/1 un.	754
30, 31, 32 e 49	Jogo de borracha	752



BASSO PANCOTTE

Produtos para Agropecuária

Equipamentos veterinários

PISTOLA SERVI OU HOPPNER:



Item	Nome	Código
1	Punho	25201
2	Gatilho	4341
3	Corpo	25202
4	Vidro temperado	2882
5	Fundo	4344
6	Bico Luer-Lock	4345
7	Unha	4346
8	Guia do eixo externo	4347
9	Porca guia n° 8	4348
10	Eixo externo	4349
11	Botão empurrador	4350
12	Porca do graduador	4351
13	Parafuso da unha	4352

14	Parafuso do gatilho	4353
15	Eixo interno	4354
16	Mola do gatilho espiral	4355
17	Mola do graduador	4356
18	Regulador de dosagem	4357
19	Parafuso de dosagem	4358
20	Placa de dosagem	4359
21	Encosto	4360
22	Bucha	4361
23	Parafuso da placa n° 20	4362
24	Borracha vulcanizada (jogo)	2885
25	Mola da unha	4364
26	Parafuso da mola n° 25	4365



BASSO PANCOTTE

Produtos para Agropecuária

Equipamentos veterinários

PISTOLA BASPAN HSW

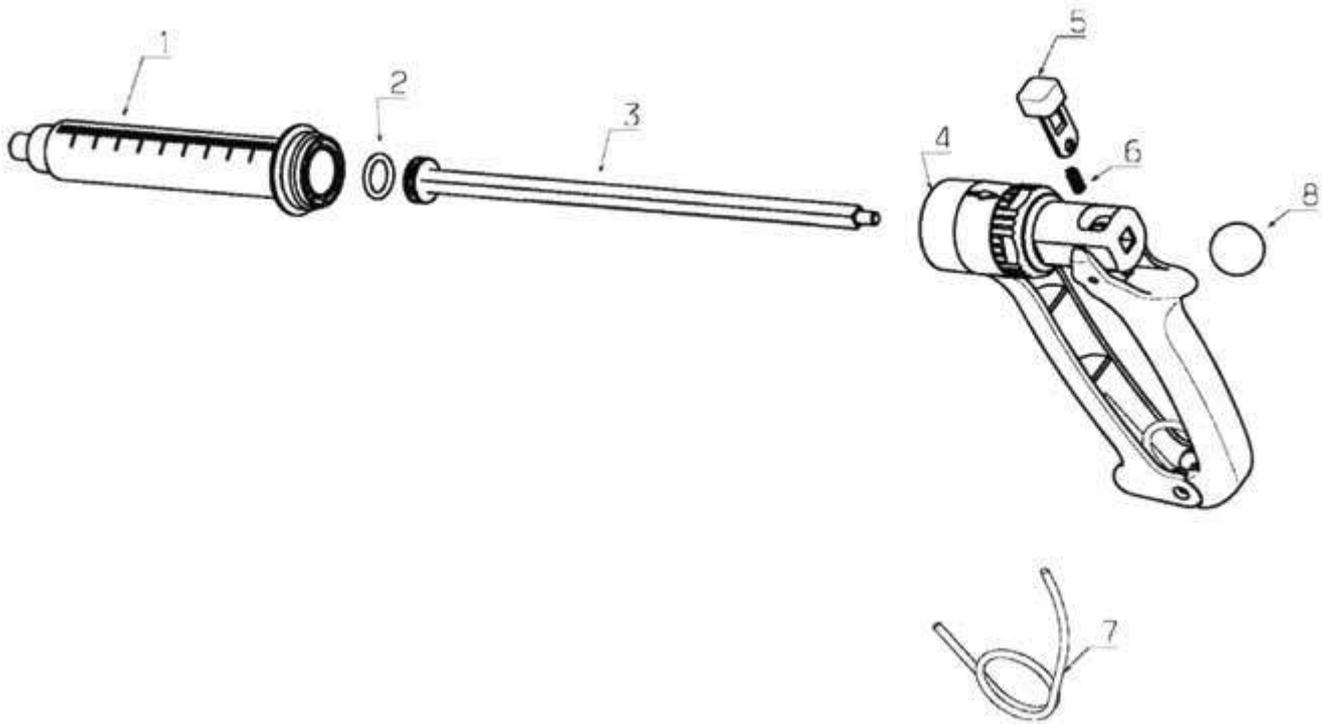

Item	Nome	Código
1	Corpo plast. PISTOLA BASPAN HSW 50 ml	33779
2	Anel bor. PISTOLA BASPAN HSW 50 ml C/2 un	33772
3	Eixo interno PISTOLA BASPAN HSW 50 ml	35541
4	Cabo completo PISTOLA BASPAN HSW 50 ml	34173
5	Trava bloqueio PISTOLA BASPAN HSW	33780
6	Mola bloqueio PISTOLA BASPAN HSW	33781
7	Mola gatilho PISTOLA BASPAN	35884
8	Botão empurador PISTOLA BASPAN	35883



BASSO PANCOTTE

Produtos para Agropecuária

Animais de companhia



Código	Descrição	Cx.
3332	ARGOLA 19 C/SOLDA NIQUELADA C/10 UNID.	1
6139	ARGOLA 22 C/SOLDA NIQUELADA C/10 UNID.	1
3338	ARGOLA 25 C/SOLDA NIQUELADA C/10 UNID.	1
3333	ARGOLA 29 C/SOLDA NIQUELADA C/10 UNID.	1
3334	ARGOLA 32 C/SOLDA NIQUELADA C/10 UNID.	1
3339	ARGOLA 38 C/SOLDA NIQUELADA C/10 UNID.	1
3335	ARGOLA 44 C/SOLDA NIQUELADA C/10 UNID.	1
3341	ARGOLA 51 C/SOLDA NIQUELADA C/10 UNID.	1
3336	ARGOLA 57 C/SOLDA NIQUELADA C/10 UNID.	1
3337	ARGOLA 63 C/SOLDA NIQUELADA C/10 UNID.	1



Código	Descrição	Cx.
4766	ARGOLA 76 C/S NIQU. PESADA C/10 UNID.	1



Código	Descrição	Cx.
6424	FREIO ARTEZ. CROMADO DOIS JOGO	1
6422	FREIO ARTEZ. ZINCADO DURO S/JOGO	1



Código	Descrição	Cx.
5035	MOSQUETAO MA 1 C/10 UNID.	30
5036	MOSQUETAO MA 2 C/10 UNID.	1



Código	Descrição	Cx.
6141	MEIA ARGOLA 16MM NIQUELADA C/10 UNID.	1
6142	MEIA ARGOLA 19MM NIQUELADA C/10 UNID.	1
6144	MEIA ARGOLA 25MM NIQUELADA C/10 UNID.	1
6145	MEIA ARGOLA 29MM NIQUELADA C/10 UNID.	1



Código	Descrição	Cx.
9925	ELO CORRENTE C/ROSCA 3,5 MM ZIN.C/10 UNID	1
9924	ELO CORRENTE C/ROSCA 5 MM ZIN.C/10 UNID	1
9923	ELO CORRENTE C/ROSCA 6 MM ZIN. C/10 UNID.	1
9922	ELO CORRENTE C/ROSCA 7 MM ZIN. C/10 UNID.	1
9921	ELO CORRENTE C/ROSCA 8 MM ZIN. C/10 UNID.	1



Código	Descrição	Cx.
32632	MOSQUETAO M -4 C/ ARG NIQ.C/10 UNID. MP0	1
2329	MOSQUETAO M -5 C/ ARG NIQ. C/10 UNID. MP1	1
2331	MOSQUETAO M -6 C/ ARG NIQ. C/10 UNID. MM2	1
2333	MOSQUETAO M -7 C/ ARG NIQ. C/10 UNID. GM3	1



Código	Descrição	Cx.
33004	MOSQUETAO DESTORC. C/ROSCA C/10 UN MR1	1
33005	MOSQUETAO DESTORC. C/ROSCA C/10 UN MR2	1



Código	Descrição	Cx.
3836	DESTORCEDOR 25 X 22 C/10 UNID.	1
3837	DESTORCEDOR 25 X 25 C/10 UNID.	1
3838	DESTORCEDOR 25 X 37 C/10 UNID.	1
3839	DESTORCEDOR 25 X 38 Q C/10 UNID.	24



Código	Descrição	Cx.
23783	CORRENTE CAO NO 2/0 C/12 UNID. WS	5
4232	CORRENTE CAO NO 3/0 C/12 UNID. WS	5
4066	CORRENTE CAO NO 0 C/12 UNID. WS	7
998	CORRENTE CAO NO 1 C/12 UNID. WS	8
3586	CORRENTE CAO NO 2 C/12 UNID. WS	10
3897	CORRENTE CAO NO 3 C/12 UNID. WS	13
689	CORRENTE CAO NO 4 C/12 UNID. WS	15
4867	CORRENTE CAO NO 5 C/12 UNID. WS	20
4684	CORRENTE CAO NO 6 C/12 UNID. WS	30
6455	CORRENTE CAO NO 7 C/12 UNID. WS	40



Código	Descrição	Cx.
2931	CORRENTE CAO NO 2/0 C/12 UNID. S RAPHAEL	1
1241	CORRENTE CAO NO 3/0 C/12 UNID. S RAPHAEL	1
1989	CORRENTE CAO NO 0 C/12 UNID. S RAPHAEL	1
1242	CORRENTE CAO NO 1 C/12 UNID. S RAPHAEL	1
1243	CORRENTE CAO NO 2 C/12 UNID. S RAPHAEL	1
1244	CORRENTE CAO NO 3 C/12 UNID. S RAPHAEL	1
1988	CORRENTE CAO NO 4 C/12 UNID. S RAPHAEL	1
1245	CORRENTE CAO NO 5 C/12 UNID. S RAPHAEL	1
1991	CORRENTE CAO NO 6 C/12 UNID. S RAPHAEL	1
1990	CORRENTE CAO NO 7 C/12 UNID. S RAPHAEL	1



BASSO PANCOTTE

Produtos para Agropecuária

Animais de companhia



Código	Descrição	Cx.
23569	MOSQUETAO C/AMORTEC.MM2 C/10 UNID.	1
23568	MOSQUETAO C/AMORTEC. GM3 C/10 UNID.	20



Código	Descrição	Cx.
33455	CRAVO P/ FERRAR B-3 C/200UN BASPAN	16
33456	CRAVO P/ FERRAR B-4 C/200UN BASPAN	16
33457	CRAVO P/ FERRAR B-5 C/200UN BASPAN	16
33458	CRAVO P/ FERRAR B-6 C/200UN BASPAN	1



Código	Descrição	Cx.
33096	CRAVO COBRA E-2 C/200 UNID	6
33097	CRAVO COBRA E-3 C/200 UNID	6
10584	CRAVO COBRA E-3 C/24 UNID	40
33098	CRAVO COBRA E-4 C/200 UNID	6
10585	CRAVO COBRA E-4 C/24 UNID	40
33099	CRAVO COBRA E-5 C/200 UNID	6
10586	CRAVO COBRA E-5 C/24 UNID	40



Código	Descrição	Cx.
4792	FERRADURA J.K. 0 NGR	8
4791	FERRADURA J.K. 2 X 0 NGR	8
4793	FERRADURA J.K. 3 NGR	8



Código	Descrição	Cx.
857	FERRADURA JOCKEY 3 LL	6
871	FERRADURA JOCKEY 3 N	6
8177	FERRADURA JOCKEY 3X0 N	6
858	FERRADURA JOCKEY 4 LL	1
872	FERRADURA JOCKEY 4 N	6
861	FERRADURA JOCKEY 5 LL	6
876	FERRADURA JOCKEY 5 N	6



Código	Descrição	Cx.
24253	FERRADURA COLONIAL "BP" NO 6 C/2 UN	25
24254	FERRADURA COLONIAL "BP" NO 7 C/2 UN	25



Código	Descrição	Cx.
3535	FERRADURA J.K. 2 X 0 NG	8
3536	FERRADURA J.K. 0 NG	8
3537	FERRADURA J.K. 1 NG	8
3538	FERRADURA J.K. 2 NG	8
3539	FERRADURA J.K. 3 NG	8
4795	FERRADURA J.K. 4 NG	8



Código	Descrição	Cx.
3545	FERRADURA J.K. LEVE 2 X 0 L	8
3546	FERRADURA J.K. LEVE 0 L	8
3547	FERRADURA J.K. LEVE 1 L	8
3548	FERRADURA J.K. LEVE 2 L	8
3549	FERRADURA J.K. LEVE 3 L	8
4789	FERRADURA J.K. LEVE 4 L	8



Código	Descrição	Cx.
2259	FERRADURA J.K. LISA 2 X 0 N	8
27674	FERRADURA J.K. LISA 3 X 0 N	8
1897	FERRADURA J.K. LISA 0 N	8
1413	FERRADURA J.K. LISA 1 N	8
1895	FERRADURA J.K. LISA 2 N	8
1896	FERRADURA J.K. LISA 3 N	8
4794	FERRADURA J.K. LISA 4 N	8
4796	FERRADURA J.K. LISA 5 N	8



Código	Descrição	Cx.
2966	ESCOVA RASP. BORRACHA (ELIO FERNANDES)	75



Código	Descrição	Cx.
562	ESCOVA C/ ALCA BOVITEC	1



Código	Descrição	Cx.
24128	RASPADORA RODO ELIO FERNAN.(CABO MADEIRA)	1



BASSO PANCOTTE

Produtos para Agropecuária

Animais de companhia



Código	Descrição	Cx.
27756	ESCOVA VASSOURA LAVAR ANIMAIS R.92	1



Código	Descrição	Cx.
1937	RASPadeira C/ALCA RCZ-100 ZINCADA	1



Código	Descrição	Cx.
23106	RASPadeira E RODO ZINCADO (CABO PLASTICO)	50



Código	Descrição	Cx.
23693	LUVA P/ LAVAR ANIMAIS (BORRACHA) P/UNID	24



Código	Descrição	Cx.
29104	ALICATE FERRADOR "JACARE" REF. 56399-13	1



Código	Descrição	Cx.
25904	GROSA FERRADOR C/CABO LAOMAAN	1



Código	Descrição	Cx.
29300	RENETE DIREITO E ESQUERDO AL1D-E LAOMAAN	5



Código	Descrição	Cx.
25905	TORQUES CASCO CROMADA (INOX) LAOMAAN	1



Código	Descrição	Cx.
2719	GROSA GABINET REG. 10 " NICHELSON C/C 17683-BC	12



Código	Descrição	Cx.
2643	GROSA NICHELSON 14 " REG PL CAVALO 18156B	6



Código	Descrição	Cx.
26311	TORQUES CORTA CASCO 14 " SAO ROMAO	12



Código	Descrição	Cx.
26310	TORQUES FERRADOR 12 " SAO ROMAO	12



BASSO PANCOTTE

Produtos para Agropecuária

Animais de companhia



Código	Descrição	Cx.
579	GROSA MEIA CANA 10' TRAM. 41710/310	12



Código	Descrição	Cx.
36913	BEBED BASPAN BOVINO C/BOIA 4 L C/4 UND	1
33270	BEBED BASPAN BOVINO C/BOIA 8 L C/4 UND	1



Código	Descrição	Cx.
5054	BUCAL NYLON CAVALO COMUM S/DESTOR	1



Código	Descrição	Cx.
8182	BUCAL NYLON VACA C/DESTORCEDOR GS	1
8184	BUCAL NYLON VACA S/DESTORCEDOR GS	1



Código	Descrição	Cx.
3827	BUCAL NYLON CAVALO C/DESTORCEDOR	1



Código	Descrição	Cx.
8185	BUCAL NYLON CAVALO S/DESTORCEDOR GS	1
8181	BUCAL NYLON CAVALO C/DESTORCEDOR GS	1



Código	Descrição	Cx.
8183	BUCAL NYLON TERNEIRO C/DESTORCEDOR GS	1
8187	BUCAL NYLON TERNEIRO S/DESTORCEDOR GS	1



Código	Descrição	Cx.
8185	BUCAL NYLON CAVALO S/DESTORCEDOR GS	1
8181	BUCAL NYLON CAVALO C/DESTORCEDOR GS	1



Código	Descrição	Cx.
26871	LACO AMERICANO FLEXIVEL 10mmX15M ENCERADO RODO CORDAS	1



Código	Descrição	Cx.
25460	LACO TRANC BRANCO/MESCLA 11mm X 12m	1
27570	LACO TRANC BRANCO/MESCLA 11mm X 14m	1



Código	Descrição	Cx.
25476	LACO TRANC RESINADO 10mmX15M CORDAVILLE	1



BASSO PANCOTTE

Produtos para Agropecuária

Animais de companhia



Código	Descrição	Cx.
4301	CITROMAX CITRONELA SPRAY REPELENTE 500ml	9



Código	Descrição	Cx.
8631	CITROMAX DOMESTICO SPRAY 500ml DELTAMETRINA	12



Código	Descrição	Cx.
4312	CITROMAX REPEL CAO 500ml	9



Código	Descrição	Cx.
4306	CITROMAX NEUTRALIZADOR ODORES 70g	12



Código	Descrição	Cx.
4308	CITROMAX RALO LIMPO 70g	12



Código	Descrição	Cx.
7975	AROMATIZANTE COALA ALGAS MARINHAS 140 ML	24



Código	Descrição	Cx.
7981	AROMATIZANTE COALA CITRONELA 140 ML	24



Código	Descrição	Cx.
7980	AROMATIZANTE COALA ERVA DOCE 140 ML	24



Código	Descrição	Cx.
7996	AROMATIZANTE COALA EUCALIPTO CITRIODORA 140 ML	24



Código	Descrição	Cx.
7972	AROMATIZANTE COALA EUCALIPTO GLOBULOS 140 ML	24



Código	Descrição	Cx.
7977	AROMATIZANTE COALA FLORAL 140 ML	24



Código	Descrição	Cx.
7979	AROMATIZANTE COALA HORTELA 140 ML	24



BASSO PANCOTTE

Produtos para Agropecuária

Animais de companhia



Código	Descrição	Cx.
7976	AROMATIZANTE COALA LAVANDA 140 ML	24



Código	Descrição	Cx.
7973	AROMATIZANTE COALA LIMA LIMAO 140 ML	24



Código	Descrição	Cx.
7974	AROMATIZANTE COALA PINHO 140 ML	24



Código	Descrição	Cx.
7978	AROMATIZANTE COALA TALCO 140 ML	24



Código	Descrição	Cx.
12029	ODORIZANTE SPRAY COALA BAMBU 120ML	24



Código	Descrição	Cx.
12030	ODORIZANTE SPRAY COALA CITRONELA 120ML	24



Código	Descrição	Cx.
12031	ODORIZANTE SPRAY COALA LAVANDA 120ML	24



Código	Descrição	Cx.
12032	ODORIZANTE SPRAY COALA TOQUE DE CARINHO 120ML	24



Código	Descrição	Cx.
12033	ODORIZANTE SPRAY COALA EUCALIPTO 120ML	24





BASSO PANCOTTE

Produtos para Agropecuária

Utilidades domésticas



Código	Descrição	Cx.
6442	COALHO ESTRELLA LIQUIDO 200 ML ENZIMA PROTEASE	12



Código	Descrição	Cx.
4109	COALHO HA-LA LIQUIDO 200 ML ENZIMA PROTEASE	1



Código	Descrição	Cx.
4108	COALHO HA-LA PO 50 G C/10 FRASCOS ENZIMA	1



Código	Descrição	Cx.
10264	COALHO HALAMIX PO 10 X 50 G UNID	8



Código	Descrição	Cx.
12675	COALHO HANILASE LIQUIDO 200 ML ENZIMA PROTEASE	32



Código	Descrição	Cx.
22912	TRIPA BOV.RETA SALG 40pc 29 cm-GETULIENSE	6



Código	Descrição	Cx.
22914	TRIPA BOV.RETA SALG. 40pc 25cm Sort Pot GETULIENSE	6



Código	Descrição	Cx.
22917	TRIPA BOV.TORTA AM 40pc 34cm - GETULIENSE	6



Código	Descrição	Cx.
7380	TRIPA SECA TORTA 5 M GETULIENSE	1



Código	Descrição	Cx.
23312	TRIPA SECA TORTA 8 M GETULIENSE calibre 42 E 44	1



Código	Descrição	Cx.
12386	TRIPA LOPESCO PAIO PACOTE 40X35 RETA	1
12387	TRIPA LOPESCO PAIO PACOTE 50X30 RETA	18



Código	Descrição	Cx.
5400	TRIPA SEMI SECA TORTA 10M LOPESCO	40



BASSO PANCOTTE

Produtos para Agropecuária

Utilidades domésticas



Código	Descrição	Cx.
269	ABRACADEIRA NYLON 57530/009 TRAM. C/100	8
34770	ABRACADEIRA NYLON 57530/020 TRAM. C/100	8
274	ABRACADEIRA NYLON 57530/028 TRAM. C/100	8



Código	Descrição	Cx.
5029	JIMO ANTIUMIDADE CABIDE 250G	6



Código	Descrição	Cx.
36180	EXPOSITOR VASSOURAS QUADRADO 3 ANDARES ODIM	1



Código	Descrição	Cx.
5285	M. MOSCA PLASTICO HARPLA	1



Código	Descrição	Cx.
5031	JIMO LIMPCAR PLUS 450ml	12



Código	Descrição	Cx.
36032	JIMO SILICONE AEROSOL 400 ML CX C/06 UNID.	1



Código	Descrição	Cx.
2450	JIMO SILICONE GEL 200 G CHEIRO CARRO NOVO	12



Código	Descrição	Cx.
2449	JIMO SILICONE GEL 200 G LAVANDA E ALGODAO	12



Código	Descrição	Cx.
6858	JIMO SILICONE GEL 200 G MARINE	12



Código	Descrição	Cx.
26739	JIMO SILICONE GEL 200 G NATURAL	12



Código	Descrição	Cx.
38088	JIMO SILICONE LIQUIDO 12 X 250 ML	1



BASSO PANCOTTE

Produtos para Agropecuária

Utilidades domésticas



Código	Descrição	Cx.
2120	BOMBA DE AR C/ PEDAL MULTIUSO BASPAN 537143	25



Código	Descrição	Cx.
2117	BOMBA DE AR P/ BICICLETA BASPAN 537130	100



Código	Descrição	Cx.
2116	BOMBA DE AR P/ BOLA BASPAN 537122	100



Código	Descrição	Cx.
38373	CALCULADORA BOLSO 12D 38373 BASPAN	200



Código	Descrição	Cx.
38365	CALCULADORA BOLSO 8D BASPAN	200



Código	Descrição	Cx.
38372	CALCULADORA CIENTIFICA 10D BASPAN	100



Código	Descrição	Cx.
38368	CALCULADORA MESA 12D BASPAN	50



Código	Descrição	Cx.
38366	CALCULADORA MESA 8D 38366 BASPAN	60



Código	Descrição	Cx.
38374	CALCULADORA MESA 16D BASPAN	60



Código	Descrição	Cx.
38367	CALCULADORA MESA 8D BASPAN	80



Código	Descrição	Cx.
38370	CALCULADORA MESA BATERIA 12D 38370 BASPAN	40



BASSO PANCOTTE

Produtos para Agropecuária

Utilidades domésticas



Código	Descrição	Cx.
8843	GUARDA CHUVA 16VAR COD 5083-16 XADRES	1



Código	Descrição	Cx.
8738	GUARDA CHUVA GRANDE 16 PRETO C.CURVO	1
10330	GUARDA CHUVA GRANDE 16 PRETO C.RETO	1



Código	Descrição	Cx.
8739	GUARDA CHUVA SOMBRINHA AUTOM. COD 2250FP PRETO	1



Código	Descrição	Cx.
8741	GUARDA CHUVA SOMBRINHA PQ COD 3950 PRETA	1



Código	Descrição	Cx.
8742	GUARDA CHUVA SOMBRINHA PQ COD 3959 FLORAL	1



Código	Descrição	Cx.
1906	DESPERTADOR QUARTZ ANALOGICO BP 378 BASPAN	50



Código	Descrição	Cx.
1914	DESPERTADOR QUARTZ ANALOGICO BP 6111 BASPAN	120



Código	Descrição	Cx.
1932	DESPERTADOR QUARTZ ANALOGICO BP 6123 BASPAN	120



Código	Descrição	Cx.
1938	RELOGIO DE PAREDE BP AN 219A BASPAN	10



Código	Descrição	Cx.
1945	RELOGIO DE PAREDE BP N10 BASPAN	10



Código	Descrição	Cx.
1954	RELOGIO DE PAREDE BP N12 BASPAN	10



Código	Descrição	Cx.
1960	RELOGIO DE PAREDE BPN051 BASPAN	6



BASSO PANCOTTE

Produtos para Agropecuária

Utilidades domésticas



Código	Descrição	Cx.
1957	RELOGIO DE PAREDE BPN906 BASPAN	10



Código	Descrição	Cx.
1962	RELOGIO DE PAREDE BPT22 BASPAN	10



Código	Descrição	Cx.
1971	RELOGIO DE PAREDE BPTP8008 BASPAN	5



Código	Descrição	Cx.
1963	RELOGIO PENDULO BP P527 BASPAN	2



Código	Descrição	Cx.
1970	RELOGIO PENDULO BP470 BASPAN	4



Código	Descrição	Cx.
23301	JIMO LAVA LOUCA PASTILHAS (25 X 20 G) 500 G	12



Código	Descrição	Cx.
36030	JIMO LIMPA VIDROS 400 ML AEROSOL CX C/06 UNID.	1



Código	Descrição	Cx.
23296	JIMO LIMPA FORNO AEROSOL 400 ML CX C/6 UND	1



Código	Descrição	Cx.
6938	JIMO MULTISUPERFICIES CX 6X400 ML	1



Código	Descrição	Cx.
38089	JIMO SECANTE ABRILHANT. P/ LOUCA 24 X 100 ML	1



Código	Descrição	Cx.
31500	CABO VASSOU. PLAST C/6 UN.X1,20M C.ROSCA	1



Código	Descrição	Cx.
12403	CABO VASSOURRÃO MAD. 1,40 MT X 28 MM C.ROSCA C/6	1



BASSO PANCOTTE

Produtos para Agropecuária

Utilidades domésticas



Código	Descrição	Cx.
29389	ESCOVA OVAL PLASTICA REF 314 ODIM	1



Código	Descrição	Cx.
34740	ESCOVA PLASTICA ANATOMICA R. 285 ODIM	36



Código	Descrição	Cx.
35692	ESCOVA SANITARIA KIT PEGA BEM REF.3607	12



Código	Descrição	Cx.
11586	ESFREGÃO MULTI ANGULOS 37421	6



Código	Descrição	Cx.
34739	LIMPA TETO C/C VERDE 2M X 22MM R. 27721 ODIM	6



Código	Descrição	Cx.
11585	LIMPA TETO FIO ESTABILIZADO C/C 2M X 22MM R. 27621 ODIM	6



Código	Descrição	Cx.
29388	PA DE LIXO REF 15114 ODIM	36



Código	Descrição	Cx.
28722	PA LIXO C/VASSOURINHA ODIM R.150	6



Código	Descrição	Cx.
34055	PA LIXO ROBUSTINHA C/C 90CM ODIM R.1520	6



Código	Descrição	Cx.
33345	RODO ODIM ACO ZINCADO 1M C/CABO R3175	6



Código	Descrição	Cx.
29393	RODO ODIM INOX 30 CM C/C R3171	12
29394	RODO ODIM INOX 40 CM C/C R3172	12
33346	RODO ODIM INOX 60 CM C/C R3174	12



BASSO PANCOTTE

Produtos para Agropecuária

Utilidades domésticas



Código	Descrição	Cx.
34741	VASSOU. D LADINHO C/C VERDE 1,20M REF 357 ODIM	12



Código	Descrição	Cx.
26353	VASSOU. DOMESTICA C/C FACEIRA 1,2M X 22MM ODIM R.354	12



Código	Descrição	Cx.
29391	VASSOU. ROBUSTA BICOLOR C/C ODIM R.358	12



Código	Descrição	Cx.
26354	VASSOU. DOMESTICA C/C PIACAVA 1,2M X 22MM ODIM R.393	12



Código	Descrição	Cx.
23179	VASSOU. P/CHAO (ESCOVA) C/C ODIM R.308	12



Código	Descrição	Cx.
29392	VASSOU. RUBRO NEGRA C/C ODIM R.369	12



Código	Descrição	Cx.
11587	VASSOURA BRASIL 350	12



Código	Descrição	Cx.
6687	VASSOURAO GARI ODIM 40CM C/C REF 38519	6
33012	VASSOURAO GARI ODIM 60CM C/C REF 600	6



Código	Descrição	Cx.
35755	VASSOURAO GARI ODIM REFORC 40CM C/C MADEIRA REF 38418	6





BASSO PANCOTTE

Produtos para Agropecuária

Utilidades domésticas



Código	Descrição	Cx.
10225	VASSOURAO GARI ODIM REFORC 60CM C/C MADEIRA REF 60018	6



Código	Descrição	Cx.
2454	CABO BP VASSOURA 1,20 M C/6 UNID. PACOTE	1



Código	Descrição	Cx.
25438	ROLHADOR DE MADEIRA	1



Código	Descrição	Cx.
23355	ROLHA CORTICA AGL. 27X23X19 C/200 UNID.	1
23356	ROLHA CORTICA AGL. 32X23X19 C/200 UNID.	25
23357	ROLHA CORTICA AGL. 32X24X24 C/200 UNID.	25



Código	Descrição	Cx.
23169	VIDRO CONSERVA 600ML C/15 UNID.	1
23170	VIDRO CONSERVA 810ML C/12 UNID.	1



Código	Descrição	Cx.
829	TAMPA VIDRO CONSERVA C/300 UNID. 74MM PACOTE	1



Código	Descrição	Cx.
25874	TAMPA VIDRO CONSERVA C/1200 UNID. CAIXA	1



Código	Descrição	Cx.
23171	TAMPA VIDRO CONSERVA C/50 UNID. 74MM PACOTE	1



Código	Descrição	Cx.
826	TAMPA VIDRO CONSERVA XADREZ C/300 UNID. 74MM PACOTE	1



Código	Descrição	Cx.
1673	BATEDOR DE CARNE (MARTELO) BPZR238	48



Código	Descrição	Cx.
1660	BICO DOSADOR PARA OLEO E VINAGRE 2PCS BPZR689	72



BASSO PANCOTTE

Produtos para Agropecuária

Utilidades domésticas



Código	Descrição	Cx.
1662	BOMBA A VACUO PARA VINHO BPZR814	48



Código	Descrição	Cx.
1665	CANTIL PORTA BEBIDA DE BOLSO 240ML BPZR778	48



Código	Descrição	Cx.
1650	CONJUNTO PARA VINHO 3 PÇS CX EM COURO BPZR749P301	24



Código	Descrição	Cx.
1657	CONJUNTO PARA VINHO 5 PÇS CX EM COURO BPZR717p502	8



Código	Descrição	Cx.
1659	CONJUNTO UTENSILIOS COM SUPORTE BPZR3685	12



Código	Descrição	Cx.
1651	CONJUNTO VIP PRA VINHO 5 PÇS CX EM COURO BPZR241P501	12



Código	Descrição	Cx.
1664	COQUETELEIRA INOX 550 ML BPZR776	24



Código	Descrição	Cx.
1369	DESCASCADOR BASPAN X102	48



Código	Descrição	Cx.
1371	ESPRESSOR DE ALHO BASPAN Y101	48



Código	Descrição	Cx.
1686	INFUSOR PARA CHA COM FILTRO BPHS702	72



Código	Descrição	Cx.
1649	KIT SACA ROLHA PROFISSIONAL BPZR607C401	12



Código	Descrição	Cx.
1364	QUEBRA NOZES BASPAN H102	48
1363	QUEBRA NOZES BASPAN H107	48



BASSO PANCOTTE

Produtos para Agropecuária

Utilidades domésticas



Código	Descrição	Cx.
1658	QUEBRA-NOZES (ESQUILO) BPBR4017	12



Código	Descrição	Cx.
1674	QUEBRA-NOZES BPZR207	72



Código	Descrição	Cx.
1648	SACA ROLHA C/ PEDESTAL BPZR633/0201	6



Código	Descrição	Cx.
1367	SACA ROLHA VINHO BASPAN K115	48



Código	Descrição	Cx.
1365	SACA ROLHA VINHO BASPAN K113	48



Código	Descrição	Cx.
1372	SACA ROLHAS 3 FUNCOES BASPAN P102	48



Código	Descrição	Cx.
1368	SACA ROLHAS BASPAN K121	8



Código	Descrição	Cx.
1695	SACA ROLHAS BPZR219/4001	72



Código	Descrição	Cx.
1667	SACA ROLHAS BPZR327	48
1693	SACA ROLHAS BPZR409	48



Código	Descrição	Cx.
1692	SACA ROLHAS BPZR409	72



Código	Descrição	Cx.
1694	TAMPA PARA CHAMPAGNE BPZR376	72



Código	Descrição	Cx.
1661	TERMOMETRO PARA VINHO BPZR670	72



BASSO PANCOTTE

Produtos para Agropecuária

Utilidades domésticas



Código	Descrição	Cx.
7512	ABRIDOR LATA E GARRAFA ZINCADO - ENCARTELADO	1



Código	Descrição	Cx.
6534	REGULADOR DE GAS APIS	50



Código	Descrição	Cx.
4847	LANCA CHAMAS GRANDE 85 CM 2 REG.	25



Código	Descrição	Cx.
23143	REGISTRO (TORNEIRA) P/ GAS P13 C/ BORBOLETA	1



Código	Descrição	Cx.
27915	REGISTRO (TORNEIRA) P/ GAS P13 S/BORBOLETA	1



Código	Descrição	Cx.
3346	MANG. GAS 1,20 M OLICAR (PEDACO) GLP NORM.	1



Código	Descrição	Cx.
2214	BALANCA DOMESTICA DIGITAL COMPACTA 5KG BASPAN BP QL-DK002	20



Código	Descrição	Cx.
2182	BALANCA DIGITAL PORTATIL C/ GANCHO 40KG	100



Código	Descrição	Cx.
2175	BALANCA DIGITAL PORTATIL C/ GANCHO 50KG	100



Código	Descrição	Cx.
2215	BALANÇA DOMESTICA DIGITAL 5KG BASPAN BP QL-DK003	12



Código	Descrição	Cx.
2224	BALANCA DOMESTICA PRATO 10KG BASPAN BP MK-004	12



BASSO PANCOTTE

Produtos para Agropecuária

Utilidades domésticas



Código	Descrição	Cx.
2204	BALANCA PESSOAL 125KG BASPAN BP	10



Código	Descrição	Cx.
2199	BALANCA PESSOAL125KG BASPAN BP	10



Código	Descrição	Cx.
2230	BALANCA PESSOAL130KG BASPAN BP	12



Código	Descrição	Cx.
2210	MINI BALANCA DIGITAL 500GR BASPAN BP CT-012	100



Código	Descrição	Cx.
37359	BALANCA DE COZINHA F 10	12



Código	Descrição	Cx.
991	CADERNAL 45 X 3 (G. S.) PEQ. 300 KG	1



Código	Descrição	Cx.
23042	CADERNAL 65 X 3 (G. S.) 800 KG	1



Código	Descrição	Cx.
5802	CALDEIRAO 2 C/ARCO TAMPA FERRO 6,5 L	1



Código	Descrição	Cx.
4132	CHALEIRA NO "1" FERRO 1,8 L C/TAMPA FERRO	1
4133	CHALEIRA NO "2" FERRO 2,8 L C/TAMPA FERRO	1



Código	Descrição	Cx.
23058	CONCHA CEREAIS GALV 500 G	50
23056	CONCHA CEREAIS GALV 1 KG	50
23057	CONCHA CEREAIS GALV 2 KG	50
24565	CONCHA CEREAIS GALV 3 KG	1
24566	CONCHA CEREAIS GALV 4 KG	20
24567	CONCHA CEREAIS GALV 5 KG	1



Código	Descrição	Cx.
12524	CONCHA CEREAIS INOX 1 KG	50
12525	CONCHA CEREAIS INOX 2 KG	50
12523	CONCHA CEREAIS INOX 500 G	50



Código	Descrição	Cx.
26930	MOINHO PARA CEREAIS ARACEBA	10



BASSO PANCOTTE

Produtos para Agropecuária

Utilidades domésticas



Código	Descrição	Cx.
33603	CANIVETE 2 LAMINAS BASPAN	30



Código	Descrição	Cx.
33602	CANIVETE 5 LAMINAS BASPAN VCA-102	30



Código	Descrição	Cx.
927	FACA CERAMICA 3" BASPAN BP EK002	100



Código	Descrição	Cx.
930	FACA CERAMICA 3" BASPAN C/ DESCASCADOR	100



Código	Descrição	Cx.
936	FACA CERAMICA 4" BASPAN C/ BAINHA BP	100
940	FACA CERAMICA 5" BASPAN C/ BAINHA BP	100
949	FACA CERAMICA 6" BASPAN C/ BAINHA BP	100



Código	Descrição	Cx.
954	FACA CERAMICA 5" SANTOKU BASPAN	100



Código	Descrição	Cx.
955	FACA CERAMICA CHEF 7" BASPAN BP EK007	100



Código	Descrição	Cx.
956	KIT CHURRASCO BASPAN BPWB227	10



Código	Descrição	Cx.
9201	CONJ CAMPEI FACA /CHAIRA 6" INOX BASPAN	1
9202	CONJ CAMPEI FACA /CHAIRA 8" INOX BASPAN	1
9203	CONJ CAMPEI FACA /CHAIRA 10" INOX BASPAN	1



Código	Descrição	Cx.
9200	FACA CAMPEIRA 10" INOX BASPAN	1
9199	FACA CAMPEIRA 8" INOX BASPAN	1
9198	FACA CAMPEIRA 6" INOX BASPAN	1



Código	Descrição	Cx.
1900	CANIVETE C/PONTA 1 LAMINA 195MM BASPAN 60040001C	100



BASSO PANCOTTE

Produtos para Agropecuária

Utilidades domésticas



Código	Descrição	Cx.
1894	CANIVETE CURVO 1 LAMINA 200MM BASPAN	100



Código	Descrição	Cx.
1901	CANIVETE INOX 11 FUNCOES BASPAN	120



Código	Descrição	Cx.
1902	ESTILETE C/ DUAS LAMINAS BASPAN	144



Código	Descrição	Cx.
27634	LAMINA SERRA FITA ACOUG.1,87 M	1



Código	Descrição	Cx.
34299	DESCASCADOR P/ CAFE 20.DCS.18	2



Código	Descrição	Cx.
12571	SERRA FITA P/ CARNE C/MOED. MESA MOVEL BIVOLT DO CHEFF	1



Código	Descrição	Cx.
8191	GANCHO CARNE INOX. 10MM 3/8 C/3UNID. GS	1
8188	GANCHO CARNE INOX. 5MM 3/16 C/5UNID. GS	1
8189	GANCHO CARNE INOX. 6,35MM 1/4 C/5 UNID GS	1
8193	GANCHO CARNE INOX. 8MM 5/16 C/5 UNID. GS	1



Código	Descrição	Cx.
6609	GANCHO CARNE INOX. 10MM 18CM UNID.	100
6607	GANCHO CARNE INOX. 6MM 13CM UNID.	1



Código	Descrição	Cx.
25599	MOEDOR PIMENTA CAIXA	1



Código	Descrição	Cx.
27334	AMACIADOR DE CARNES BOM BIFE 14 CM (78337)	3



Código	Descrição	Cx.
24374	CILINDRO ANODILAR CROMADO 506 25 CM	1
24375	CILINDRO ANODILAR CROMADO 510 28 CM	1



BASSO PANCOTTE

Produtos para Agropecuária

Utilidades domésticas



Código	Descrição	Cx.
24373	CILINDRO ANODILAR MARIELLA 530 28 CM (445 122)	8



Código	Descrição	Cx.
24697	CILINDRO MULTIMASSAS ANODILAR 502 (813 203)	1

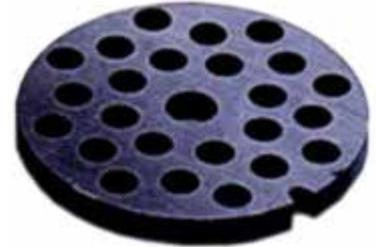

Código	Descrição	Cx.
5480	DISCO P/PICADOR NR.10 ACO 10 MM	1
5482	DISCO P/PICADOR NR.22 ACO 15 MM	1



Código	Descrição	Cx.
31422	FACA PICADOR NO 10 ANODILAR	1



Código	Descrição	Cx.
31423	FACA PICADOR NO 22 ANODILAR	1



Código	Descrição	Cx.
35243	MAQUINA PICADOR CARNE 10 ANODILAR	1



Código	Descrição	Cx.
37350	CORTADOR DE LEGUMES REF 510	1



Código	Descrição	Cx.
6610	GANCHO CARNE ZINCADO 6MM 1/4	1
6611	GANCHO CARNE ZINCADO 8MM 5/16	1
6612	GANCHO CARNE ZINCADO 10MM 3/8	1
32169	GANCHO CARNE ZINCADO 12MM 7/16	1



Código	Descrição	Cx.
12680	MAQUINA PICADOR CARNE 22 MALTA	4



Código	Descrição	Cx.
834	FUNIL DE NYLON P/PICAD.N.10	1
842	FUNIL DE NYLON P/PICAD.N.22	1



Código	Descrição	Cx.
2242	PEDRA AFIAR CANOA 198 CX C/20 UNID. CABORUNDUM	6



BASSO PANCOTTE

Produtos para Agropecuária

Utilidades domésticas



Código	Descrição	Cx.
2243	PEDRA P/AFIAR COMB. 108-8" CARBORUNDUM	50
2844	PEDRA P/AFIAR COMB. 109-6" CARBORUNDUM	50



Código	Descrição	Cx.
23849	ABRIDOR CONJUGADO TRAM. 26330/100	12



Código	Descrição	Cx.
23816	CANIVETE INOX C/6 UND (C/PONTA) TRAM	40
23851	CANIVETE INOX C/6 UNID. (S/PONTA) TRAM	40

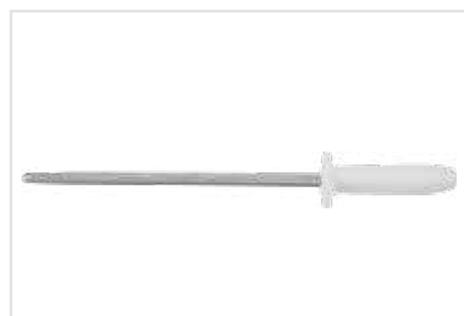

Código	Descrição	Cx.
32958	CHAIRA TRAMONTINA ESTRIADA 8" 22969/188	60



Código	Descrição	Cx.
1303	CHAIRA TRAMONTINA ESTRIADA PROFESSIONAL10" 24642/080	12



Código	Descrição	Cx.
4107	COLHER CHA 6 PCS POLYWOOD 21107/690 TRAM	30



Código	Descrição	Cx.
4105	COLHER MESA 6 PCS POLYWOOD 21103/690 TRAM	30



Código	Descrição	Cx.
29586	CONJ. COLHERES INOX 3PC N.KOLOR AZUL	60



Código	Descrição	Cx.
29587	CONJ. COLHERES CHA INOX 3 PC N.KOLOR AZUL	12



Código	Descrição	Cx.
29584	CONJ. FACAS INOX 3 PC N.KOLOR AZUL 23160/314	60



Código	Descrição	Cx.
29585	CONJ. GARFOS INOX 3PC N.KOLOR AZUL 23162/310	60



Código	Descrição	Cx.
567	CONJ. FACA/GARFO TRAM. 23099/083 ENCAR.	20



BASSO PANCOTTE

Produtos para Agropecuária

Utilidades domésticas



Código	Descrição	Cx.
34268	FACA CARNE TRAM 23084/007 INOX	120



Código	Descrição	Cx.
23847	FACA TRAM CAMPEIRA 26080/177 C/BAINHA	24



Código	Descrição	Cx.
4057	FACA TRAM CARNE PREMIUM EN CART.	60



Código	Descrição	Cx.
4058	FACA TRAM CARNE PREMIUM 24473/188 ENCARTEL.	60



Código	Descrição	Cx.
4059	FACA TRAM CARNE PREMIUM 24476/188 ENCARTEL.	60



Código	Descrição	Cx.
23843	FACA TRAM CARNE PROF. 24609/088 INOX	60



Código	Descrição	Cx.
25474	FACA TRAM CARNE PROF. 24620/088 INOX	60



Código	Descrição	Cx.
23842	FACA TRAM CARNE PROF.24607/088 INOX	60



Código	Descrição	Cx.
24331	FACA TRAM CHURASCO 21199/722 INOX	10



Código	Descrição	Cx.
23808	FACA TRAM COREAR 24606/086	60



Código	Descrição	Cx.
23848	FACA TRAM CUTELO COZINHA 22956/006	60



Código	Descrição	Cx.
23807	FACA TRAM DESOSSAR 24602/085	60



BASSO PANCOTTE

Produtos para Agropecuária

Utilidades domésticas



Código	Descrição	Cx.
4052	FACA TRAM DESOSSAR PREMIUM 24471/185 ENCARTEL.	60



Código	Descrição	Cx.
29450	FACA TRAM INOX COZINHA 22921/006	120
23803	FACA TRAM INOX COZINHA 22921/007	120
23804	FACA TRAM INOX COZINHA 22921/008	120



Código	Descrição	Cx.
37858	FACA TRAM PEIXEIRA CARB.22950/005 C/12	20
23805	FACA TRAM PEIXEIRA CARB.22950/006	240
23806	FACA TRAM PEIXEIRA CARB.22950/007	120
23840	FACA TRAM PEIXEIRA CARB.22950/008	120



Código	Descrição	Cx.
476	FACA TRAM PEIXEIRA INOX ENCARTELADA 5"	60
477	FACA TRAM PEIXEIRA INOX ENCARTELADA 6"	60
480	FACA TRAM PEIXEIRA INOX ENCARTELADA 8"	60



Código	Descrição	Cx.
23844	FACA TRAM SPORT 26003/106 DESTAMP.C/ BAINHA	12



Código	Descrição	Cx.
23809	FACA TRAM SPORT FILETAR 26053/106 c/afiador e bainha	12



Código	Descrição	Cx.
4096	FACAS 6 PCS POLYWOOD 21100/695 TRAM	30



Código	Descrição	Cx.
4097	GARFO 6 PCS POLYWOOD 21102/690 TRAM	30



Código	Descrição	Cx.
24318	GARFO INOX CABO COMP.TRAM 22231/100	12



Código	Descrição	Cx.
487	JOGO CHURRASCO INOX 12PCS POLYWOOD 21199/903 TRAM	10



Código	Descrição	Cx.
2046	JOGO CHURRASCO INOX 8PCS POLYWOOD 21198/465 TRAM	1



Código	Descrição	Cx.
4110	JOGO FACA CHAIRA 3PCS PREMIUM 24499/812 TRAM	20



BASSO PANCOTTE

Produtos para Agropecuária

Utilidades domésticas



Código	Descrição	Cx.
4076	JOGO FACA GARFO 2PCS PREMIUM 24499/815 TRAM	10



Código	Descrição	Cx.
23813	JOGO TRAM FACA C/3 23360/335 INOX	60

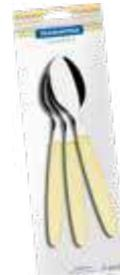

Código	Descrição	Cx.
23811	JOGO TRAM COLHER SOPA C/3 23363/330 INOX	60



Código	Descrição	Cx.
575	PIPOQUEIRA ALUM. 22CM TRAM. 20536/722	1



Código	Descrição	Cx.
555	JOGO UTENSILIOS NYLON 3PC 25099/014 TRAM	10



Código	Descrição	Cx.
9268	JOGO UTENSILIOS NYLON 4PC 25299/607 EASY TRAM	6



Código	Descrição	Cx.
546	TESOURA TRAM INOX CABELEIREIRO 25905/106	120



Código	Descrição	Cx.
29590	RALADOR UNIVINOX UTILAR BRANCO 25106/480	48



Código	Descrição	Cx.
29591	SACA-ROLHAS/ABR.INOX BRANCO 26330/180	60



Código	Descrição	Cx.
37286	TESOURA TRAM COSTUREIRA "8" 25912/108	48



Código	Descrição	Cx.
28598	TESOURA TRAM INOX PROFISSIONAL 25914/100	48



Código	Descrição	Cx.
24883	TESOURA TRAM INOX PEIXE ACO 25922/108	48



BASSO PANCOTTE

Produtos para Agropecuária

Utilidades domésticas



Código	Descrição	Cx.
24884	TESOURA TRAM INOX USO GERAL 25950/148	48



Código	Descrição	Cx.
29574	COLHER CHA INOX COPACAB 63901/072 TRAM	360



Código	Descrição	Cx.
29570	COLHER INOX M.COPACAB. 63901/012 TRAM	240



Código	Descrição	Cx.
29573	COLHER SOBREMESA INOX COPAC. 63901/042 TRAM	360



Código	Descrição	Cx.
29575	CONCHA TERRINA INOX COPACAB.63901/091 TRAM	48



Código	Descrição	Cx.
29577	FACA CHURRASCO INOX COPACAB.63901/182 TRAM	60



Código	Descrição	Cx.
29572	FACA MESA INOX COPACAB.63901/032 TRAM	60



Código	Descrição	Cx.
29571	GARFO MESA INOX COPACAB. 63901/022 TRAM	60



Código	Descrição	Cx.
29569	PEGADOR P/MASSA INOX 63800/600 TRAM	30



Código	Descrição	Cx.
29582	FERVEDOR ALUMINIO 10 CM PRETO 20540/610	6
29583	FERVEDOR ALUMINIO 14 CM PRETO 20540/614	6



Código	Descrição	Cx.
35309	JOGO PANELAS ACO INOX 5PCS ALLEGRA 65650/280 TRAM	3



Código	Descrição	Cx.
1763	PRENSA P/BANHA 12 L ZATTI (MEDIA)	1
32056	PRENSA P/BANHA 22 L ZATTI (GRANDE)	1



BASSO PANCOTTE

Produtos para Agropecuária

Utilidades domésticas



Código	Descrição	Cx.
23724	LAMINA SERRA ACOUGUE 40 CM FOLHA	10
34851	LAMINA SERRA ACOUGUE 45 CM FOLHA	10
3022	LAMINA SERRA ACOUGUE 50 CM FOLHA	10
6390	LAMINA SERRA ACOUGUE 55 CM FOLHA	10
3023	LAMINA SERRA ACOUGUE 60 CM FOLHA	10



Código	Descrição	Cx.
23434	SERRA PARA ACOUGUE 40 CM VOPER 16 POL	30
34850	SERRA PARA ACOUGUE 45 CM VOPER 18 POL	1
3025	SERRA PARA ACOUGUE 50 CM VOPER 20 POL	2
26437	SERRA PARA ACOUGUE 55 CM VOPER 22 POL	30
23435	SERRA PARA ACOUGUE 60 CM VOPER 24 POL	30



Código	Descrição	Cx.
8346	CANO GALV. FOGAO 110MM CX C/ 9 UN	1
27042	CANO GALV. FOGAO 115MM CX C/ 9 UN	1
8347	CANO GALV. FOGAO 120MM CX C/ 9 UN	1



Código	Descrição	Cx.
32276	CHAPEU CHINES CX C/6 UN	1



Código	Descrição	Cx.
32271	CHAPEU FIXO CX C/6 UN	1



Código	Descrição	Cx.
32270	CHAPEU GALO CX C/ 6 UN	1



Código	Descrição	Cx.
32272	CURVA 115MM CX C/4 UN	1



Código	Descrição	Cx.
37523	JOELHO P/CANO DE FOGAO 115MM CX C/4 UNID	1



Código	Descrição	Cx.
32274	TELHA 4MM 50 CM CX C/6 UN	1
32275	TELHA 6MM 50 CM CX C/ 6 UN	1



Código	Descrição	Cx.
32273	TELHA NORMAL CX C/6 UN	1



Código	Descrição	Cx.
4493	FRIGIDEIRA FERRO C/CAB.REDONDA 23CM	12

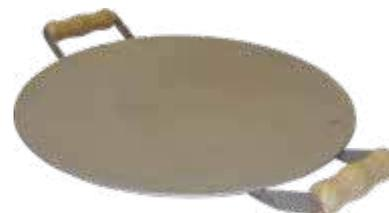

Código	Descrição	Cx.
4566	BIFEIRA ACO 18" C/CABO MADEIRA	1



BASSO PANCOTTE

Produtos para Agropecuária

Utilidades domésticas



Código	Descrição	Cx.
5204	DISCO P/ASSADOS ESMALTADO 16" 40 CM	1



Código	Descrição	Cx.
35693	DISCO P/ASSADOS ESMALTADO 16" C/ BORDA	1



Código	Descrição	Cx.
29579	FRIGIDEIRA ALUMINIO 16 CM PRETA 20180/016 TRAM	12



Código	Descrição	Cx.
29580	FRIGIDEIRA ALUMINIO 20 CM PRETA 20180/020 TRAM	12



Código	Descrição	Cx.
29581	FRIGIDEIRA ALUMINIO 24 CM PRETA 20180/024 TRAM	12



Código	Descrição	Cx.
9336	PALITOS DENTAIS 100 UN 25x100 GABOARDI	20
9337	PALITOS DENTAIS 200 UN 20x200 GABOARDI	20



Código	Descrição	Cx.
9501	ESPETINHOS P/CHURRASCO 3,5mm X 250mm c/100und GABOARDI	50



Código	Descrição	Cx.
9502	ESPETINHOS P/CHURRASCO BAMBU 250mm C/50und GABOARDI	100



Código	Descrição	Cx.
9403	FILME MULTIUSO UTILFILME 28cm X 15m GABOARDI	25



Código	Descrição	Cx.
10261	SACOLA BRANCA VIRGEM 30X40x0,16 C/1000 und	1
10262	SACOLA BRANCA VIRGEM 38X48x0,20 C/1000 und	1
10263	SACOLA BRANCA VIRGEM 48X58x0,24 C/1000 und	1



Código	Descrição	Cx.
10079	SACOS DE LIXO EM ROLO BOBI 15 L C/20un AZUL	20
10080	SACOS DE LIXO EM ROLO BOBI 30 L C/10un AZUL	20
10081	SACOS DE LIXO EM ROLO BOBI 50 L C/10un AZUL	20
10082	SACOS DE LIXO EM ROLO BOBI 100 L C/5un AZUL	20



Código	Descrição	Cx.
10083	SACOS DE LIXO ENVELOPA 15 L C/10un PRETO	25
10084	SACOS DE LIXO ENVELOPA 30 L C/10un PRETO	25
10085	SACOS DE LIXO ENVELOPA 50 L C/10un PRETO	25
10086	SACOS DE LIXO ENVELOPA 100 L C/5un PRETO	25



BASSO PANCOTTE

Produtos para Agropecuária

Utilidades domésticas



Código	Descrição	Cx.
10087	SACOLA RECI CX 30x45x0,006 EXTR FORTE 2 KG	1
10088	SACOLA RECI CX 40x50x0,006 EXTR FORTE 3 KG	1
10089	SACOLA RECI CX 50x60x0,006 EXTR FORTE 5 KG	1



Código	Descrição	Cx.
4377	FORMA MUSSARELA 3 KG BOVITEC	100



Código	Descrição	Cx.
25822	FORMA QUEIJO INOX C/REGULAGEM	1



Código	Descrição	Cx.
564	FORMA QUEIJO 1 KG BOVITEC REDONDA	1
24500	FORMA QUEIJO 500 G BOVITEC REDONDA	40



Código	Descrição	Cx.
4147	FORMA QUEIJO 500 G CRISAN REDONDA	100
4148	FORMA QUEIJO 1 KG CRISAN REDONDA	50



Código	Descrição	Cx.
1762	PRENSA P/QUEIJO REDONDA ZATTI	1



Código	Descrição	Cx.
2768	PRENSA P/QUEIJO QUADRADA ZATTI (RETANGULAR)	1



Código	Descrição	Cx.
426	TIGELA P/ SALADA BAMBOO BASPAN 21310	12



Código	Descrição	Cx.
387	ROLO P/ MASSA BAMBOO BASPAN 2301	24



Código	Descrição	Cx.
460	TABUA P/ CORTE BAMBOO BASPAN 14002 - 1	12



Código	Descrição	Cx.
394	TABUA REDONDA P/ CORTE BAMBOO BASPAN BP1486	12



Código	Descrição	Cx.
386	TABUA REDONDA P/ CORTE BAMBOO BASPAN 14032-2	12



BASSO PANCOTTE

Produtos para Agropecuária

Utilidades domésticas



Código	Descrição	Cx.
456	BANDEJA BAMBOO BP 1	10
457	BANDEJA BAMBOO BP 2	12
458	BANDEJA BAMBOO BP 3	12



Código	Descrição	Cx.
412	BANDEJA C/ ALCA BAMBOO BASPAN 1606 - 1	12



Código	Descrição	Cx.
405	COLHERES BAMBOO BASPAN B1315	480



Código	Descrição	Cx.
396	COLHERES BAMBOO BASPAN 1301	240



Código	Descrição	Cx.
392	COLHERES BAMBOO BASPAN BP1335	240



Código	Descrição	Cx.
438	CONJ. DE POTES P/ ALIM. BAMBOO BASPAN 1012 - 1	12



Código	Descrição	Cx.
455	CONJUNTO P/ APERITIVOS BAMBOO BASPAN 1232	24



Código	Descrição	Cx.
384	CONJUNTO P/ COZINHA BAMBOO BASPAN 1301	6



Código	Descrição	Cx.
428	CONJUNTO PORTA TEMPEROS BAMBOO BASPAN 1111 - 1	24



Código	Descrição	Cx.
452	CONJUNTO P/ PETISCOS BAMBOO BASPAN 1222	12
413	CONJUNTO P/ PETISCOS BAMBOO BASPAN 1233	12
415	CONJUNTO P/ PETISCOS BAMBOO BASPAN 1234	12



Código	Descrição	Cx.
421	CONJUNTO P/ PETISCOS BAMBOO BASPAN 1228	12



Código	Descrição	Cx.
450	CONJUNTO PARA COPOS BAMBOO BASPAN 1817	24



BASSO PANCOTTE

Produtos para Agropecuária

Utilidades domésticas



Código	Descrição	Cx.
431	CONJUNTO RACK E PORTA TEMPEROS BAMBOO BASPAN 1205	12



Código	Descrição	Cx.
451	DESCANCO P/ PANELA BAMBOO BASPAN 1814	48



Código	Descrição	Cx.
409	PEGADOR MULTI USO BAMBOO BASPAN 1314 - 3	104



Código	Descrição	Cx.
422	PETISQUEIRA 4 DIV. BAMBOO BASPAN 1235	8



Código	Descrição	Cx.
388	PETISQUEIRA BAMBOO 2 DIV. BASPAN 3000	48
389	PETISQUEIRA BAMBOO 3 DIV. BASPAN 3001	72



Código	Descrição	Cx.
449	PORTA TALHERES BAMBOO BASPAN 2000	12



Código	Descrição	Cx.
447	PORTA UTENSÍLIOS BAMBOO BASPAN 3102	24
443	PORTA UTENSÍLIOS VAZADO BAMBOO BASPAN 3105S	48



Código	Descrição	Cx.
381	CUMBUCA E PILÃO BAMBOO BASPAN 1006	24



Código	Descrição	Cx.
437	POTE P/ ALIMENTOS BAMBOO BASPAN 1003	24



Código	Descrição	Cx.
433	POTE P/ ALIMENTOS BAMBOO BASPAN 1013	24



Código	Descrição	Cx.
377	CONJUNTO P/ PATÊ BAMBOO BASPAN 1236	8



Código	Descrição	Cx.
453	TABUA P/ CORTAR PÃO BAMBOO BASPAN 1504	12



BASSO PANCOTTE

Produtos para Agropecuária

Piscina



Código	Descrição	Cx.
11574	ADAPTADOR ROSCA PLAST ASPIRACAO REF. 12.0007 BRUSTEC	50



Código	Descrição	Cx.
9757	ASPIRADOR ESCOVA ASA DELTA REF. 01.0001 BRUSTEC	5



Código	Descrição	Cx.
12576	ASPIRADOR ESCOVA JUMBO REF. 01.0075	4



Código	Descrição	Cx.
9756	ASPIRADOR ESCOVA REF. 01.0003 BRUSTEC	5



Código	Descrição	Cx.
11359	CABO ASPIRADOR REPOSIÇÃO ASA DELTA/ ESCOVA BRUSTEC	1



Código	Descrição	Cx.
9764	CABO DE ALUMINIO 3 M REF. 05.0001 BRUSTEC	25
9765	CABO DE ALUMINIO 4 M REF. 05.0002 BRUSTEC	25



Código	Descrição	Cx.
9758	CLORADOR MARGARIDA GRANDE REF. 03.0002 BRUSTEC	24



Código	Descrição	Cx.
9759	CLORADOR MEDIO REF. 03.0001 BRUSTEC	23



Código	Descrição	Cx.
9760	ESCOVA CURVA REF. 02.0001 BRUSTEC	15
9761	ESCOVA RETA REF. 02.0002 BRUSTEC	15



Código	Descrição	Cx.
9762	PENEIRA CATA FOLHA PLASTICA REF. 04.0001 BRUSTEC	12



Código	Descrição	Cx.
9763	PENEIRA METALICA REF. 04.0002 BRUSTEC	20



Código	Descrição	Cx.
11575	PONTEIRA DIREITA MANGUEIRA SILICONADA REF. 06.0001 BRUSTEC	50



BASSO PANCOTTE

Produtos para Agropecuária

Piscina



Código	Descrição	Cx.
11576	PONTEIRA ESQUERDA MANGUEIRA AZUL REF 06.0002 BRUSTEC	100



Código	Descrição	Cx.
10059	MANG. FLUTUANTE PISCINA 1.1/2 25 M OLICAR 3101.01	1



Código	Descrição	Cx.
9317	HCL ALGICIDA MANUTENCAO 1 L	20
11515	HCL ALGICIDA MANUTENCAO 5 L	4



Código	Descrição	Cx.
9395	HCL ALGICIDA CHOQUE 1 L	20
11514	HCL ALGICIDA CHOQUE 5 L	4



Código	Descrição	Cx.
9318	HIDROFLOC IMP 1 L FLOCULANTE/CLARIFICANTE	20
11513	HIDROFLOC IMP 5 L FLOCULANTE/CLARIFICANTE	4



Código	Descrição	Cx.
9518	SULFATO DE ALUMINIO 2 Kg	10



Código	Descrição	Cx.
12305	HCL HYPO 10 Kg CLORO GRANULADO (Hipoclorito de Cálcio)	1



Código	Descrição	Cx.
9812	HCL PENTA CX 12 X 200g CLORO TABLETE	1
9310	HCL PENTA CX 60 X 200g CLORO TABLETE	1



Código	Descrição	Cx.
9311	HCL PENTA TUBETE + FLUTUADOR CX 12 X 1,4 Kg CLORO TABLETE	1



Código	Descrição	Cx.
12306	HCL TRI 10 Kg CLORO	1



Código	Descrição	Cx.
9312	HIDROSAN PENTA 1 Kg CLORO	20
9314	HIDROSAN PENTA 10 Kg CLORO	1
9313	HIDROSAN PENTA 2,5 Kg CLORO	1
9316	HIDROSAN PLUS 10 Kg CLORO	1
9315	HIDROSAN PLUS 2,5 Kg CLORO	1



Código	Descrição	Cx.
9417	HIPOCLOR 10 Kg CLORO GRANULADO	1
10415	HIPOCLOR 2,5 Kg CLORO GRANULADO	1



BASSO PANCOTTE

Produtos para Agropecuária

Piscina



Código	Descrição	Cx.
9320	HIDROSAN LIMPA BORDAS 1 L	20



Código	Descrição	Cx.
10782	HIDRO PH + 1 L ELEVADOR DE PH	20



Código	Descrição	Cx.
9319	HIDRO PH + 2 Kg ELEVADOR DE PH (BARRILHA LEVE)	10



Código	Descrição	Cx.
9396	ASPIRADOR ESCOVA JUMBO REF 01.0075	20



Código	Descrição	Cx.
10427	HIDROALL ELIMINADOR DE OLEOSIDADE 1 L	20



Código	Descrição	Cx.
10780	HIDROCALCIO 5 Kg CLORETO DE CALCIO	1



Código	Descrição	Cx.
9637	KIT TESTE POOL TEST 50 Tiras	1



Código	Descrição	Cx.
9517	PH ESTAVEL 2 Kg ELEVADOR DE ALCALINIDADE	10



Código	Descrição	Cx.
10417	REAGENTE REFIL ORTOTOLIDINA 23 ML ANALISE CLORO	1



Código	Descrição	Cx.
10416	REAGENTE REFIL VERMELHO FENOL 23 ml ANALISE pH	1



Código	Descrição	Cx.
11033	KIT TESTE ALCALINIDADE PREMIUM	1



Código	Descrição	Cx.
9397	KIT TESTE PH E CLORO PREMIUM	1

PADO

Mais que produtos, tranquilidade!



#CadeadodoBrasil



 /padobr
 @padobr
www.pado.com.br



BASSO PANCOTTE

Produtos para Agropecuária

Construção civil



Código	Descrição	Cx.
7493	FITA ADESIVA 3M TARTAN 5808 45MMX45 M C/4 ROLOS	20



Código	Descrição	Cx.
35990	ADESIVO PARA CANOS POLY 17 G CX C/48 UNID	1
35991	ADESIVO PARA CANOS POLY75 G CX C/30 UNID	1



Código	Descrição	Cx.
23383	SILICONE POLYSTIC 280 G ZB060	15



Código	Descrição	Cx.
25821	COLA MADEIRA 100 G PULVITEC IA022	24



Código	Descrição	Cx.
23384	MASSA POLYEPOX 100 G DA002	48



Código	Descrição	Cx.
27700	DUREPOXI 100G	48
34858	DUREPOXI 50G	48



Código	Descrição	Cx.
1035	SUPER BONDER 24 X 3 G CAIXA C/24 UNID. ORIGINAL	1



Código	Descrição	Cx.
6699	CADEADO PADO 20MM	1
6700	CADEADO PADO 25MM	10
6701	CADEADO PADO 30MM	10
6702	CADEADO PADO 35MM	5
6703	CADEADO PADO 40MM	5
6704	CADEADO PADO 45MM	1
6705	CADEADO PADO 50MM	5
6706	CADEADO PADO 60MM	5



Código	Descrição	Cx.
6461	CADEADO STAM NO 20 MM	480
6462	CADEADO STAM NO 25 MM	240
6463	CADEADO STAM NO 30 MM	200
6464	CADEADO STAM NO 35 MM	180
27503	CADEADO STAM NO 40 MM	10
6465	CADEADO STAM NO 45 MM	100



Código	Descrição	Cx.
1940	CATRACA P/ AVIARIO CINFER	4



Código	Descrição	Cx.
26988	CATRACA C/ROSETA CX C/12 "CACULA"	10



Código	Descrição	Cx.
4903	FECHO PORTAO PAPAGAIO LOTH C/6 UNID.	16



BASSO PANCOTTE

Produtos para Agropecuária

Construção civil



Código	Descrição	Cx.
3231	FERROLHO PARA PORTAO 30CM C/3 UNID	10



Código	Descrição	Cx.
3232	GANCHO DE REDE LOTH C/12 UNID.	20



Código	Descrição	Cx.
38402	PNEU ARO 3,25x8 P/CARRINHO DE MAO BASPAN	20



Código	Descrição	Cx.
33364	CAMARA AR 3.50X8 CARRINHO MAO LEVORIN	50
5605	CAMARA AR CARRINHO MAO 3.25 X 8 LEVORIN	50



Código	Descrição	Cx.
38403	CAMARA AR CARRINHO MAO 3.25 X 8 BASPAN	100



Código	Descrição	Cx.
22902	PNEU 3,25X8 P/CARRINHO DE MAO S/ARO LEVORIN	10



Código	Descrição	Cx.
12526	ARO CARRINHO MAO ACO S/PNEU CX C/2 UND	1



Código	Descrição	Cx.
23832	ARO CARRINHO MAO ACO S/PNEU	3



Código	Descrição	Cx.
26529	ARO CARRINHO MAO PLASTICO S/PNEU	3



Código	Descrição	Cx.
2919	ARO COMP C/PNEU/CAMARA 3,25X8 ACO	3



Código	Descrição	Cx.
26530	ARO COMP C/PNEU/CAMARA 3.25X8 PLASTICO	3



Código	Descrição	Cx.
24475	ARO COMPLETO MACICO CAR.DE MAO	3



BASSO PANCOTTE

Produtos para Agropecuária

Construção civil



Código	Descrição	Cx.
23455	CACAMBA PLASTICA 60 L PVC METASUL	3



Código	Descrição	Cx.
26763	CACAMBA - TERMOPLASTICO 90 L PARABONI	1



Código	Descrição	Cx.
4131	CACAMBA METAL PARABONI	1



Código	Descrição	Cx.
33868	CARRI.MAO ALZA CAC PLAST 90 L	1



Código	Descrição	Cx.
32182	CARRINHO DE MAO CANTONEIRA REFORC.	1



Código	Descrição	Cx.
26762	CARRI.MAO CAC.PLAST.90 L. ARO*METAL*3,25	1



Código	Descrição	Cx.
23454	CARRI.MAO CACAM.METAL* ARO.METAL* 3,25	1
24854	CARRI.MAO CACAM.*PLAST* ARO*PLAST* 3,25	1



Código	Descrição	Cx.
8449	CARRI.MAO CAC.PLAST.160 L. ARO3,25 METAL PARABONI	1



Código	Descrição	Cx.
474	CARRI.MAO CAC.METAL. TRAMONTINA	1





Zagonel[®]

Tecnologia eficiente

As *melhores* soluções
em *duchas e torneiras!*



30
1989
2019
Anos





BASSO PANCOTTE

Produtos para Agropecuária

Construção civil



Código	Descrição	Cx.
463	TESTADOR SLIM E-27 TASCIBRA	1



Código	Descrição	Cx.
8041	EXPOSITOR LAMP ENCARTELADOS OUROLUX	1



Código	Descrição	Cx.
462	EXPOSITOR TAS 04 ENCARTELADOS TASCIBRA	1



Código	Descrição	Cx.
35393	HASTE PARA CHUVEIRO 30CM ZAGONEL	1
35394	HASTE PARA CHUVEIRO 40CM ZAGONEL	1



Código	Descrição	Cx.
36172	DUCHA LINEA 127V. 3 TEMP 5.000W ZAGONEL	1
36171	DUCHA LINEA 220V. 3 TEMP 5.500W ZAGONEL	12



Código	Descrição	Cx.
34953	DUCHA MASTER BANHO 127V. 5.500W	1
34952	DUCHA MASTER BANHO 220V. 6.700W	1



Código	Descrição	Cx.
34955	DUCHA POP IDEALE 127V. 4 TEMP 5.000W	1
34954	DUCHA POP IDEALE 220V. 4 TEMP 6.000W	1



Código	Descrição	Cx.
36702	DUCHA SUBLIME 127V 5.500W ELETRONIC	8
36701	DUCHA SUBLIME 220V 7.500W ELETRONIC	1



Código	Descrição	Cx.
37550	DUCHA ZAGONEL MOVE 5.500W 127V	8
37549	DUCHA ZAGONEL MOVE 7.500W 220V	1



Código	Descrição	Cx.
36174	RESISTENCIA DUCHA LINEA/AGILE 127V	1
36175	RESISTENCIA DUCHA LINEA/AGILE 220V	1



Código	Descrição	Cx.
34957	RESISTENCIA DUCHA MASTER LUXO 127V	1
34956	RESISTENCIA DUCHA MASTER LUXO 220V	1



Código	Descrição	Cx.
34958	RESISTENCIA DUCHA POP/IDEALE/SUPER 127V	1
34959	RESISTENCIA DUCHA POP/IDEALE/SUPER 220V	1



BASSO PANCOTTE

Produtos para Agropecuária

Construção civil



Código	Descrição	Cx.
37863	RESISTENCIA DUCHA SUBLIME/MOVE 127v	1
37864	RESISTENCIA DUCHA SUBLIME/MOVE 220v	1



Código	Descrição	Cx.
8195	RESISTENCIA PRATICA 220 V	1
8194	RESISTENCIA PRATICA 127 V	1



Código	Descrição	Cx.
36967	TORNEIRA ZAGONEL SUPER 127V 5.000W	6



Código	Descrição	Cx.
13230	TORNEIRA TOUCH PRATICA ELETR. 5.000W 127V	1
13231	TORNEIRA TOUCH PRATICA ELETR. 5.500W 220V	1



Código	Descrição	Cx.
13235	TORN. PRIMA TOUCH ELET. BLACK 5.000W 127V	1
13233	TORN. PRIMA TOUCH ELET. BLACK 5.500W 220V	1



Código	Descrição	Cx.
13234	TORN. PRIMA TOUCH ELET. BRANCA 5.000 W 127V	1
13232	TORN. PRIMA TOUCH ELET. BRANCA 5.500W 220V	1



Código	Descrição	Cx.
37547	TORNEIRA ZAGONEL AGILE 4.500W 127V	12
37548	TORNEIRA ZAGONEL AGILE 4.500W 220V	1



Código	Descrição	Cx.
37545	TORNEIRA ZAGONEL PRATICA ELETR. 5.500W 220V	1



Código	Descrição	Cx.
2943	TORNEIRA 1/2 P/LAVATORIO HERC 1195	60



Código	Descrição	Cx.
4489	CORREDICA LEVE P/PORTEIRA (PAR) CINFER	2



Código	Descrição	Cx.
4589	DOBRADICA PORTAO FERRADURA 8" N-2P	10
4590	DOBRADICA PORTAO FERRADURA 10" N-3P	10
5808	DOBRADICA PORTAO FERRADURA 14" N-5P	10



Código	Descrição	Cx.
23114	DOBRADICA LEME 4" UNID	132
23115	DOBRADICA LEME 6" UNID	96
23116	DOBRADICA LEME 8" UNID	72
23709	DOBRADICA LEME 10" UNID.	60
23710	DOBRADICA LEME 12" UNID.	60



BASSO PANCOTTE

Produtos para Agropecuária

Construção civil



Código	Descrição	Cx.
27050	DOBRADICA PORTAO 4" 2 HASTE UNID	1
28388	DOBRADICA PORTAO 6" 2 HASTE UNID	1
3229	DOBRADICA PORTAO 8" 2 HASTE UNID	54
3230	DOBRADICA PORTAO 10" 2 HASTE UNID	1
4588	DOBRADICA PORTAO 12" 2 HASTE UNID	54



Código	Descrição	Cx.
34324	DOBRADICA FERRADURA C.00 SAO ROMAO	6
26573	DOBRADICA FERRADURA C.01 SAO ROMAO	6
26305	DOBRADICA FERRADURA C.02 SAO ROMAO	6
26306	DOBRADICA FERRADURA C.03 SAO ROMAO	6
26307	DOBRADICA FERRADURA C.04 SAO ROMAO	6
26574	DOBRADICA FERRADURA C.06 SAO ROMAO	6
36177	DOBRADICA FERRADURA C.08 SAO ROMAO	6



Código	Descrição	Cx.
6633	DOBRADICA POLIDA 1,5" CAIXA C/24 UNID.	80
3445	DOBRADICA POLIDA 2" CAIXA C/24 UNID.	56
3446	DOBRADICA POLIDA 2,5" CAIXA C/24 UNID.	28
3447	DOBRADICA POLIDA 3" CAIXA C/24 UNID.	22
3444	DOBRADICA POLIDA 3,5" CAIXA C/24 UNID.	14
3448	DOBRADICA POLIDA 4" CAIXA C/24 UNID.	9



Código	Descrição	Cx.
9894	ADAPTADOR TRAMONTINA 2P+T 10A 250V BRANCO 57400/098	30



Código	Descrição	Cx.
11710	FITA ISOLANTE 10M 57540010 C/10 UNID.	6
11711	FITA ISOLANTE 20M 57540020 C/10 UNID.	6
11712	FITA ISOLANTE 5M 57540005 C/10 UNID.	6



Código	Descrição	Cx.
278	FITA ISOLANTE COLORIDA 10M PT C/35 UNID. 57540/910 TRAMONTINA	2



Código	Descrição	Cx.
35479	MANG. CORRUGADO LEVA DN25-3/4 50M 57505/002	1



Código	Descrição	Cx.
23259	DISJUNTOR TRIPOLAR 50-A LORENZETTI	6
23250	DISJUNTOR UNIPOLAR 10-A LORENZETTI	6
23256	DISJUNTOR UNIPOLAR 40-A LORENZETTI	6



Código	Descrição	Cx.
7536	DISJUNTOR TRIPOLAR 40- DIN TRAMONTINA	4
7527	DISJUNTOR UNIPOLAR 10- DIN TRAMONTINA	12
7529	DISJUNTOR UNIPOLAR 16- DIN TRAMONTINA	12
7531	DISJUNTOR UNIPOLAR 20- DIN TRAMONTINA	12
7532	DISJUNTOR UNIPOLAR 25- DIN TRAMONTINA	12
7533	DISJUNTOR UNIPOLAR 32- DIN TRAMONTINA	12
7534	DISJUNTOR UNIPOLAR 40- DIN TRAMONTINA	12
7535	DISJUNTOR UNIPOLAR 50- DIN TRAMONTINA	12



Código	Descrição	Cx.
38037	EXTENSAO 3 TOM 2P+T 10A-250V 3 MT TRAM	12
38039	EXTENSAO 5 TOM 2P+T 10A-250V 3 MT TRAM	12



Código	Descrição	Cx.
31876	EXTENSAO TRAM 10M 57502/010 CABO 1,5	6



Código	Descrição	Cx.
26677	EXTENSAO TRAM 5 M AZUL 57410/970	6



BASSO PANCOTTE

Produtos para Agropecuária

Construção civil



Código	Descrição	Cx.
31874	EXTENSAO TRAM CABIDE 10M CABO 1,0	1



Código	Descrição	Cx.
28230	FIO FLEXIVEL 750V 1,5MM BRANCO 100M	1
28231	FIO FLEXIVEL 750V 1,5MM PRETO 100M	1
28212	FIO FLEXIVEL 750V 10MM AZUL 100M	1
28213	FIO FLEXIVEL 750V 10MM BRANCO 100M	1
28214	FIO FLEXIVEL 750V 10MM PRETO 100M	1
28215	FIO FLEXIVEL 750V 10MM VERMELHO 100M	1
28227	FIO FLEXIVEL 750V 2,5MM PRETO 100M	1
28228	FIO FLEXIVEL 750V 2,5MM VERMELHO 100M	1
28220	FIO FLEXIVEL 750V 4MM AZUL 100M	1
28224	FIO FLEXIVEL 750V 4MM VERMELHO 100M	1
28217	FIO FLEXIVEL 750V 6MM BRANCO 100M	1
28219	FIO FLEXIVEL 750V 6MM VERMELHO 100M	1



Código	Descrição	Cx.
28201	FIO PARALELO 300V - 2 X 1,5MM BRANCO 100M	1
28200	FIO PARALELO 300V - 2 X 2,5MM BRANCO 100M	1



Código	Descrição	Cx.
10632	CARREGADOR USB TOMADA DUPLA BRANCO	12
10616	CARREGADOR USB TOMADA DUPLA PRETO	12



Código	Descrição	Cx.
23263	INTERRUPTOR EXTERNO 1063-P LORENZETTI	10



Código	Descrição	Cx.
27231	TOMADA TELEF C/PLACA 1242 LORENZETTI	20



Código	Descrição	Cx.
25276	TOMADA UNIV. EXT. 1713010-RET. LORENZETTI	20
23249	TOMADA UNIV. EXT. 1716010-CIRC. LORENZETTI	20



Código	Descrição	Cx.
38033	INT PARALELO HOTEL 10A/250V 57145/002 TRAM	10



Código	Descrição	Cx.
38036	INT SIMPLES + TOMADA C/PLACA 2P+T 10A/250V 57145/064 TRAM	10



Código	Descrição	Cx.
38031	INT SIMPLES C/PLACA 10A/250V 57145/001 TRAM	10



Código	Descrição	Cx.
38032	INT SIMPLES C/PLACA DUPLA 10A/250V 57145/040 TRAM	10



BASSO PANCOTTE

Produtos para Agropecuária

Construção civil



Código	Descrição	Cx.
26679	INTERRUPTOR 1 T. SIMP. 57400/004 C/10 UNDRAMONT	5



Código	Descrição	Cx.
38030	PLACA CEGA LUX 2 4X2 57105/001 TRAM	20



Código	Descrição	Cx.
38034	TOMADA C/PLACA 2P+T NBR 14136 10A/250V	10



Código	Descrição	Cx.
38035	TOMADA C/PLACA DUPLA 2P+T NBR 14136 10A/250V 57145/065 TRAM	10



Código	Descrição	Cx.
27304	TOMADA RET. POTE C/24 6 CO 57420/949 TRAM.	2



Código	Descrição	Cx.
26681	TOMADA UNI TRAMONTINA 57400/048	50



Código	Descrição	Cx.
1750	PLUG " T " 3 PINOS C/10 UND 57400/080 TRAMONTINA	10



Código	Descrição	Cx.
26678	PLUG " T " 57400/070 UNID.TRAMONTINA	100



Código	Descrição	Cx.
629	PLUG FEMEA 3P TRAM UNID . UNIVER 57402/053	50



Código	Descrição	Cx.
27303	PLUG FEMEA MINI POTE C/24 57421/952 TRAM.	2



Código	Descrição	Cx.
1504	PLUG FEMEA TRAM UNID . UNIVER	750



Código	Descrição	Cx.
627	PLUG MACHO 3 PINOS 57403/003 TRAM	50



BASSO PANCOTTE

Produtos para Agropecuária

Construção civil



Código	Descrição	Cx.
29277	PLUG MACHO M. POTE C/42 6 CORES 57421/901 TRAM.	2



Código	Descrição	Cx.
1503	PLUG MACHO UNIVE. 57401/002 C/10 UNID. TRAM	80



Código	Descrição	Cx.
27345	PLUG "T" POTE C/24 57420/970 TRAM.	2



Código	Descrição	Cx.
10187	PORTA LAMPADA (SOQUETE FIXO) E27 4A/250V 57499/093 TRAM	40



Código	Descrição	Cx.
23246	PORTA LAMPADA PEND. C/ RABICHO 1560-NFP LORENZET	50



Código	Descrição	Cx.
23243	PORTA LAMPADA PENDENTE 1527-FP LORENZETTI	50



Código	Descrição	Cx.
23244	PORTA LAMPADA PORCELANA 1592-FP LORENZETTI	10



Código	Descrição	Cx.
1101	LAMPADA LED 9W BIVOLT BPY-F534 BASPAN	30



Código	Descrição	Cx.
1324	LAMPADA EMBUTIR LED 10W BIVOLT LP-DL	40



Código	Descrição	Cx.
978	LAMPADA EMBUTIR LED 12W BIVOLT BPY-F-545	12
966	LAMPADA EMBUTIR LED 5W BIVOLT BPY-F542	100
984	LAMPADA EMBUTIR LED 15W BIVOLT BPY-F546	12



Código	Descrição	Cx.
985	LAMPADA EMBUTIR LED 6W BIVOLT BPY-F563	50
986	LAMPADA EMBUTIR LED 12W BIVOLT BPY-F565	40



Código	Descrição	Cx.
1336	LAMPADA EMBUTIR LED 3W BIVOLT LP-DL	36
1337	LAMPADA EMBUTIR LED 5W BIVOLT LP-DL	36
1338	LAMPADA EMBUTIR LED 7W BIVOLT LP-DL	36
1339	LAMPADA EMBUTIR LED 9W BIVOLT LP-DL	24
1340	LAMPADA EMBUTIR LED 12W BIVOLT LP-DL	24
1341	LAMPADA EMBUTIR LED 15W BIVOLT LP-DL	18
1347	LAMPADA EMBUTIR LED 18W BIVOLT LP-DL	18



BASSO PANCOTTE

Produtos para Agropecuária

Construção civil

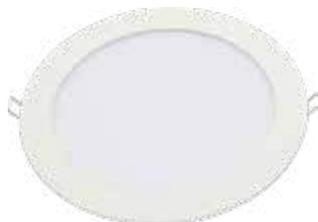

Código	Descrição	Cx.
990	LAMPADA EMBUTIR LED 18W BIVOLT BPY-F567 BASPAN	20



Código	Descrição	Cx.
992	LAMPADA EMBUTIR LED 6W BIVOLT BPY-F421	50
995	LAMPADA EMBUTIR LED 9W BIVOLT BPY-F422	40
1000	LAMPADA EMBUTIR LED 12W BIVOLT BPY-F423	40



Código	Descrição	Cx.
1361	LAMPADA EMBUTIR LED 20W BIVOLT QUAD. LPDL BASPAN	18



Código	Descrição	Cx.
1325	LAMPADA EMBUTIR LED 30W BIVOLT LPDL BASPAN	12



Código	Descrição	Cx.
964	LAMPADA EMBUTIR LED 3W BIVOLT BPY-F541	100
971	LAMPADA EMBUTIR LED 9W BIVOLT BPY-F544	40



Código	Descrição	Cx.
1102	LAMPADA LED 12W BIVOLT BPY-F535 BASPAN	20



Código	Descrição	Cx.
1333	LAMPADA EMBUTIR LED 5W BIVOLT LP-COB	32
1334	LAMPADA EMBUTIR LED 20W BIVOLT LP-COB	10
1335	LAMPADA EMBUTIR LED 30W BIVOLT LP-COB	8



Código	Descrição	Cx.
1099	LAMPADA LED 5W BIVOLT BPY-F532 BASPAN	50



Código	Descrição	Cx.
1348	LAMPADA 0,6 MT LED 10W BIVOLT LPTL BASPAN CX C/4	1



Código	Descrição	Cx.
1358	LUMINÁRIA 1,2M LED 20W BIVOLT LPTL BASPAN CX C/4	1



Código	Descrição	Cx.
1357	LUMINÁRIA 0,6M LED 10W BIVOLT LPTL BASPAN CX C/4	1

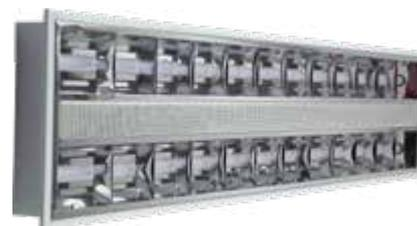

Código	Descrição	Cx.
1359	LUMINÁRIA LED 32W BI LED.JD.F.V(2X16 W) CX/2	1
1362	LUMINÁRIA LED 32W BI LED.JD.F.V (4X8 W) CX/2	1
1360	LUMINÁRIA LED 64W BIVOLT LED (4X16W) CX C/2	1



BASSO PANCOTTE

Produtos para Agropecuária

Construção civil



Código	Descrição	Cx.
1320	REFLETOR LED 10W 220 VOL. RD-FD BASPAN	34



Código	Descrição	Cx.
1321	REFLETOR LED 20W BIVOLT RD-FD BASPAN	30
1322	REFLETOR LED 30W BIVOLT RD-FD BASPAN	20
1323	REFLETOR LED 50W BIVOLT RD-FD BASPAN	10



Código	Descrição	Cx.
1097	LAMPADA LED SPOT 20W BIVOLT BPY-G143 BASPAN	20



Código	Descrição	Cx.
165	LAMPADA COMP ELET 3U 15W 127V TASCHIBRA	10
166	LAMPADA COMP ELET 3U 15W 220V TASCHIBRA	10
168	LAMPADA COMP ELET 3U 20W 127V TASCHIBRA	10
169	LAMPADA COMP ELET 3U 20W 220V TASCHIBRA	10



Código	Descrição	Cx.
8081	LAMPADA ECO HALOGENA H100 70W E27 127V	100
7994	LAMPADA ECO HALOGENA H100 70W E27 220V	100
8105	LAMPADA ECO HALOGENA H150 120W E27	100
8080	LAMPADA ECO HALOGENA H60 42W E27	100
7993	LAMPADA ECO HALOGENA H60 42W E27	100



Código	Descrição	Cx.
7989	LAMPADA SUPERLED 30 4,7W E27 BIVOLT 6500K	50
7990	LAMPADA SUPERLED 40 6W E27 BIVOLT 6500K	10
7991	LAMPADA SUPERLED 60 9W E27 BIVOLT 6500K	10
7992	LAMPADA SUPERLED 80 12W E27 BIVOLT 6500K	10



Código	Descrição	Cx.
7995	LAMPADA SL TUB. GLASS LED 18W CX/10 1,2 BIVOLT 6400K	1



Código	Descrição	Cx.
2108	CINTO DUPLO P/ FERRAM. EM NYLON BASPAN BJT228T	20



Código	Descrição	Cx.
2105	PORTA MARTELO GIRATARIO DE COURO BASPAN BJT234	100



Código	Descrição	Cx.
2088	CINTO DUPLO P/ FERRAMENTAS EM COURO BASPAN BJT228	20



Código	Descrição	Cx.
2087	CINTO P/ FERRAMENTAS BASPAN BJT 226	20



Código	Descrição	Cx.
2104	PORTA MARTELO DE COURO BASPAN BJT 233	100



BASSO PANCOTTE

Produtos para Agropecuária

Construção civil



Código	Descrição	Cx.
3825	EMENDA " S " 1/4 6 MM C/10 UNID.	1
3824	EMENDA " S " 3/16 4,75 MM C/10 UNID	1



Código	Descrição	Cx.
3832	ROLDANA VARAL C/GANCHO C/5 UNID.	1
3831	ROLDANA VARAL S/GANCHO C/5 UNID.	1



Código	Descrição	Cx.
2542	BALDE METAL PEDREIRO PRETO METASUL	1



Código	Descrição	Cx.
2543	BALDE PLASTICO PEDREIRO PRETO METASUL	12



Código	Descrição	Cx.
22750	CAIXA MASSA PLAST(0.58X0.38X0.14)METASUL	1



Código	Descrição	Cx.
6055	DESEMP METASUL 14X27 PLAST ESTRIADA	12
28541	DESEMP METASUL 17X30 PLAST C/ESPUMA	12



Código	Descrição	Cx.
22720	DESEMP METASUL ACO DENTADA	12



Código	Descrição	Cx.
22749	ESPACADOR DE PISO 8MM C/100 PLASTICO	6



Código	Descrição	Cx.
7603	LAPIS CARPINEIRO LUFKIN (NICHOLSON)	1



Código	Descrição	Cx.
33200	CINTO DE COURO CARPINEIRO "REFORÇADO"	14



Código	Descrição	Cx.
37343	CINTO ELETRICISTA PROFISSIONAL	1



Código	Descrição	Cx.
24773	COLHER PARABONI 8 " P/ PEDREIRO C/C	6
6120	COLHER PARABONI 9 " P/ PEDREIRO C/C	6



BASSO PANCOTTE

Produtos para Agropecuária

Construção civil



Código	Descrição	Cx.
26723	NIVEL DE MADEIRA 16" PARABONI	6



Código	Descrição	Cx.
5405	ALICATE TRAM. AZULEJI 41068/308	30



Código	Descrição	Cx.
5281	FORMAO CHANFRADO 1 " 43330/107 TRAM	12



Código	Descrição	Cx.
5195	FORMAO CHANFRADO 1/2" 43330/103 TRA	12
5279	FORMAO CHANFRADO 1/4" 43330/101 TRA	12
5196	FORMAO CHANFRADO 3/4" 43330/105 TRA	12
5280	FORMAO CHANFRADO 3/8" 43330/102 TRA	12



Código	Descrição	Cx.
1163	METRO MADEIRA 1M TRAM. 43160/001	12
580	METRO MADEIRA 2M TRAM. 43160/002	12



Código	Descrição	Cx.
5199	NIVEL ALUM.14" 43100/014 ECON. TRAM	6



Código	Descrição	Cx.
5223	PRUMO 500 G 43180/001 TRAMONTINA	12



Código	Descrição	Cx.
34987	SERRA MARMORE 4.1/2 220V 1.300W TRAMON	2



Código	Descrição	Cx.
1872	COLHER TRAM. 8 " PEDREIRO 77358/085	12
1946	COLHER TRAM. 9 " PEDREIRO 77358/095	12



Código	Descrição	Cx.
6010	CINTO DE COURO PARA CARPINTEIRO	60



Código	Descrição	Cx.
36414	ARCO DE PUA S/ CATRACA IRWIN	1



Código	Descrição	Cx.
3064	BROCA A.R.STAND 6,50MM " C/10 UNID.PACOTE	10
3066	BROCA A.R.STAND 7,50MM " C/5 UNID.PACOTE	1
3067	BROCA A.R.STAND 8,00MM " C/5 UNID.PACOTE	1



BASSO PANCOTTE

Produtos para Agropecuária

Construção civil



Código	Descrição	Cx.
3086	BROCA CHATA 6.1/8" - 5/16" 150 MM IRWIN	1



Código	Descrição	Cx.
3078	BROCA CONCR.12MM 15CM C/5 UNID.PACOTE IRWIN	10



Código	Descrição	Cx.
22904	BROCA CONCRETO IRWIN 8 MM 33 CM	5



Código	Descrição	Cx.
3080	BROCA TELHA FIBRO CIM.E MOU 3/8" X 320MM	1
3081	BROCA TELHA FIBRO-CIM.E MOU 1/2" X 400MM	6
3079	BROCA TELHA FIBRO-CIM.E MOU 5/16" X 280MM	1



Código	Descrição	Cx.
28929	EXPOSITOR PARA BROCAS IRWIN 105 PCS	1



Código	Descrição	Cx.
542	BROCA A.R. TRAM. 10,00MM 43141/144 UNID.	5
543	BROCA A.R. TRAM. 12,00MM 43141/149 UNID.	5
527	BROCA A.R. TRAM. 2,00MM 43141/106 UNID.	10
529	BROCA A.R. TRAM. 3,00MM 43141/113 UNID.	10
530	BROCA A.R. TRAM. 4,00MM 43141/122 UNID.	10
533	BROCA A.R. TRAM. 5,00MM 43141/129 UNID.	10
534	BROCA A.R. TRAM. 6,00MM 43141/133 UNID.	10
535	BROCA A.R. TRAM. 7,00MM 43141/136 UNID.	10
537	BROCA A.R. TRAM. 8,00MM 43141/138 UNID.	5
538	BROCA A.R. TRAM. 9,00MM 43141/142 UNID.	5



Código	Descrição	Cx.
561	BROCA CONCRETO TRAM. 10,00MM 15CM	5
563	BROCA CONCRETO TRAM. 12,00MM 15CM	5
553	BROCA CONCRETO TRAM. 4,00MM 7,5CM	10
554	BROCA CONCRETO TRAM. 5,00MM 8,5CM	10
556	BROCA CONCRETO TRAM. 6,00MM 10CM	10
557	BROCA CONCRETO TRAM. 8,00MM 12CM	10



Código	Descrição	Cx.
31688	DISCO DIAMANTADO ATC IRWIN LISO	5



Código	Descrição	Cx.
31691	DISCO DIAMANTADO ATC IRWIN SEMENTADO	5



Código	Descrição	Cx.
31690	DISCO DIAMANTADO ATC IRWIN TURBO	5



Código	Descrição	Cx.
6401	FERRO PUA MATHIESON STAND 1/4 X 8	1
6403	FERRO PUA MATHIESON STAND 3/8 X 8	40
26403	FERRO PUA MATHIESON STAND 5/8 X 8	1
6400	FERRO PUA MATHIESON STAND. 1/2 X 8	1



Código	Descrição	Cx.
31877	SERRA VIDIA CIRCULAR IRWIN 4.3/8 12 DENTES	20
31878	SERRA VIDIA CIRCULAR IRWIN 7.1/4 24 DENTES	10



BASSO PANCOTTE

Produtos para Agropecuária

Construção civil



Código	Descrição	Cx.
33319	TRENA 3 M BASPAN	120
33320	TRENA 5 M BASPAN	120
33321	TRENA 7,5 M BASPAN	72



Código	Descrição	Cx.
23739	MANG. NIVEL CRISTAL 50 M 5/16 X 2MM	1
2921	MANG. NIVEL CRISTAL 50 M 3/8" X 1 MM	1
5710	MANG. NIVEL CRISTAL 50M 1/2" X 1,50MM	1



Código	Descrição	Cx.
23378	FITA VEDA ROSCA 12 X 10 MT MA032	60
23379	FITA VEDA ROSCA 12 X 25 MT MA041	30
23380	FITA VEDA ROSCA 18 X 10 MT MA033	60
23381	FITA VEDA ROSCA 18 X 25 MT MA034	30



Código	Descrição	Cx.
9100	ADAPTADOR INTERNO 1/2" C/25 UNID. (rural)	1
9099	ADAPTADOR INTERNO 3/4" C/25 UNID. (rural)	1



Código	Descrição	Cx.
2591	JOELHO INTERNO 90 1/2" C/25 UNID. (rural)	1
2592	JOELHO INTERNO 90 3/4" C/25 UNID. (rural)	1



Código	Descrição	Cx.
2596	TE INTERNO 90 1/2" C/25 UNID. (serie rural)	10
2597	TE INTERNO 90 3/4" C/25 UNID. (serie rural)	10



Código	Descrição	Cx.
2599	TE INTERNO TRIPLO 1/2" C/25 UNID. (rural)	10
2600	TE INTERNO TRIPLO 3/4" C/25 UNID. (rural)	1



Código	Descrição	Cx.
27895	TUBO DE POLIETILENO 1" X 1,8 X 100M	1
5071	TUBO DE POLIETILENO 1" X 2,5 X 100M	1
25140	TUBO DE POLIETILENO 1" 1/2 X 3,5 X 50 M	1
4461	TUBO DE POLIETILENO 1" 1/4 X 3,0 X 50M	1
1909	TUBO DE POLIETILENO 1/2" X 1,5 X 100M	1
1910	TUBO DE POLIETILENO 1/2" X 2,0 X 100M	1
26809	TUBO DE POLIETILENO 1/2" X 2,5 X 100M	1
1911	TUBO DE POLIETILENO 3/4" X 1,5 X 100M	1
1912	TUBO DE POLIETILENO 3/4" X 2,0 X 100M	1
5622	TUBO DE POLIETILENO 3/4" X 2,5 X 100M	1
1908	TUBO DE POLIETILENO 3/8" X 1,5 X 100M	1



Código	Descrição	Cx.
2603	UNIAO INTERNA 1" C/25 UNID. (serie rural)	10
2574	UNIAO INTERNA 1/2" C/25 UNID. (serie rural)	1
9098	UNIAO INTERNA 3/4" C/25 UNID. (serie rural)	1



Código	Descrição	Cx.
35055	BUCHA RED.SOLD.LONGA 40 X 20MM C/15 UNID	1
35056	BUCHA RED.SOLD.LONGA 40 X 25MM C/10 UNID	1



Código	Descrição	Cx.
35057	CURVA 90 SOLD - 20MM C/20 UNID	1
35058	CURVA 90 SOLD - 25MM C/20 UNID	1
35059	CURVA 90 SOLD - 40MM C/10 UNID	1



**CHEGAMOS À
CASA DOS 25 ANOS
E EM MILHÕES DE
RESIDÊNCIAS.**



**QUEM
QUESTIONA
USA
KRONA**



KRONA
TUBOS E CONEXÕES

Água fria • Água quente • Esgoto • Esgoto série reforçada • Elétrica • Acessórios

asuaobra.com.br



krona.com.br



BASSO PANCOTTE

Produtos para Agropecuária

Construção civil



Código	Descrição	Cx.
35060	JOELHO 45 SOLD - 20MM C/50 UNID	1
35062	JOELHO 45 SOLD - 40MM C/10 UNID	1
35063	JOELHO 45 SOLD - 50MM C/10 UNID	1



Código	Descrição	Cx.
35068	JOELHO 90 RED. SOLD 25 X 20MM C/20 UNID	1



Código	Descrição	Cx.
35064	JOELHO 90 SOLD - 20MM C/50 UNID	1
35065	JOELHO 90 SOLD - 25MM C/50 UNID	1
35067	JOELHO 90 SOLD - 50MM C/25 UNID	1



Código	Descrição	Cx.
35093	JOELHO 90 SOLD C/BUCHA LATAO 20MM X 1/2	1
35095	JOELHO 90 SOLD C/BUCHA LATAO 25MM X 1/2	1
35094	JOELHO 90 SOLD C/BUCHA LATAO 25MM X 3/4	1



Código	Descrição	Cx.
35085	JOELHO 90 SOLD E ROSCA (LR) 25MM X 1/2 C/30 UNID	1



Código	Descrição	Cx.
35083	JOELHO 90 SOLD E ROSCA 20MM X 1/2	1
35084	JOELHO 90 SOLD E ROSCA 25MM X 3/4	1



Código	Descrição	Cx.
35075	LUVA DE CORRER P/TUBO SOLD.40MM C/6 UNID	1



Código	Descrição	Cx.
35076	LUVA RED. SOLD. 25 X 20MM C/50 UNID	1



Código	Descrição	Cx.
6567	LUVA ROSCAVEL 1/2 (BRANCA)	1
23386	LUVA ROSCAVEL 3/4 (BRANCA)	1



Código	Descrição	Cx.
35069	LUVA SOLD - 20MM C/50 UNID	1
35070	LUVA SOLD - 25MM C/50 UNID	1
35071	LUVA SOLD - 40MM C/10 UNID	1
35072	LUVA SOLD - 50MM C/10 UNID	1



Código	Descrição	Cx.
35096	LUVA SOLD C/BUCHA LATAO 20MM X 1/2 C/20	1
35097	LUVA SOLD C/BUCHA LATAO 25MM X 3/4 C/20	1



Código	Descrição	Cx.
35086	LUVA SOLD E ROSCA (LR) 20MM X 1/2	1
35088	LUVA SOLD E ROSCA (LR) 25MM X 1/2	1
35087	LUVA SOLD E ROSCA (LR) 25MM X 3/4	1
35089	LUVA SOLD E ROSCA (LR) 40MM X 1.1/4	1
35090	LUVA SOLD E ROSCA (LR) 50MM X 1.1/2	1



BASSO PANCOTTE

Produtos para Agropecuária

Construção civil



Código	Descrição	Cx.
35049	NIPEL ROSCAVEL 1/2 C/50 UNID	1



Código	Descrição	Cx.
35050	PLUG ROSCAVEL 1/2 C/50 UNID	1



Código	Descrição	Cx.
35051	PLUG ROSCAVEL 3/4 C/50 UNID	1



Código	Descrição	Cx.
35475	TAMPA P/VALVULA P/TANQUE C/100 UNID T2	1



Código	Descrição	Cx.
35081	TE RED SOLD - 25 X 20MM C/20 UNID	1
35082	TE RED SOLD - 40 X 25MM C/10 UNID	1



Código	Descrição	Cx.
35078	TE SOLD - 25MM C/50 UNID	1
35079	TE SOLD - 40MM C/10 UNID	1
35080	TE SOLD - 50MM C/10 UNID	1



Código	Descrição	Cx.
35099	TE SOLD C/BUCHA LATAO 20MM X 1/2	1
35101	TE SOLD C/BUCHA LATAO 25MM X 1/2	1
35100	TE SOLD C/BUCHA LATAO 25MM X 3/4	1



Código	Descrição	Cx.
35092	TE SOLD E ROSCA (LR) 25MM X 1/2 C/20 UNID	1



Código	Descrição	Cx.
35102	VALVULA P/PIA UNID KRONA	20



Código	Descrição	Cx.
23136	SIFAO SANFONADO PLASTICO METASUL	12



Código	Descrição	Cx.
28776	LIGACAO FLEXIVEL 40 CM REF 1185 C/12 LUCONI	1
35500	LIGACAO FLEXIVEL 50 CM REF 1186 C/12 LUCONI	20



Código	Descrição	Cx.
34966	TORNEIRA BOIA P/BEBEDOURO COD.0012 CIPLA	12



BASSO PANCOTTE

Produtos para Agropecuária

Construção civil



Código	Descrição	Cx.
6722	TORNEIRA BOIA P/CX D'AGUA 1/2 CIPLA	20
6723	TORNEIRA BOIA P/CX D'AGUA 3/4 CIPLA	20



Código	Descrição	Cx.
6724	TORNEIRA BOIA P/CX DESC. EXT. CIPLA	10



Código	Descrição	Cx.
28020	TORNEIRA FILTRO 5/8 1104. C/12 UNID. PACOTE	1



Código	Descrição	Cx.
38323	TORNEIRA BOIA P/ BEB. ANIMAL REF.1168	1



Código	Descrição	Cx.
28849	TORNEIRA BOIA P/CX D'AGUA 1/2 LUCONI 1162C	1
28850	TORNEIRA BOIA P/CX D'AGUA 3/4 LUCONI 1165	120



Código	Descrição	Cx.
28848	TORNEIRA BOIA P/CX DESC. EXT. 1/2 LUCONI 1167	1



Código	Descrição	Cx.
3316	TELA MOSQ.TRANC BRANCA 1,00M X 50M	1
3317	TELA MOSQ.TRANC BRANCA 1,20M X 50M	1
23013	TELA MOSQ.TRANC BRANCA 1,50M X 50M	1



Código	Descrição	Cx.
6312	TELA MOSQ.TRANC CINZA 1,00M X 50M	1
6313	TELA MOSQ.TRANC CINZA 1,20M X 50M	1
23014	TELA MOSQ.TRANC CINZA 1,50M X 50M	1



Código	Descrição	Cx.
1903	TELA MOSQ.TRANC VERDE 1,00M X 50M	1
1904	TELA MOSQ.TRANC VERDE 1,20M X 50M	1
23015	TELA MOSQ.TRANC VERDE 1,50M X 50M	1



Código	Descrição	Cx.
25554	TELA MOSQ.TECNOFIL BRANCA 1,2M X 50M	1
24548	TELA MOSQ.TECNOFIL BRANCA 1,5M X 50M	1
24547	TELA MOSQ.TECNOFIL BRANCA 1M X 50M	1



Código	Descrição	Cx.
25778	TELA MOSQ.TECNOFIL VERDE 1,2M X 50M (NÓ)	1
24550	TELA MOSQ.TECNOFIL VERDE 1,5M X 50M (NÓ)	1
24549	TELA MOSQ.TECNOFIL VERDE 1M X 50M (NÓ)	1

CIPLA

**Torneira de Boia
1/2"**



**Torneira de Boia
3/4"**



**Torneira de Boia
para Bebedouro**



**Torneira de Boia
1/2" para Caixa de Descarga**

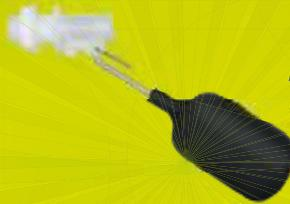

**Adaptador com
Rosca Externa:
1/2" a 4"**



**Joelho Interno:
1/2" a 2"**

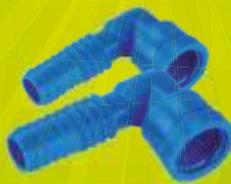

**Tê Interno:
1/2" a 2"**



**Tê Interno Triplo:
1/2" a 1"**

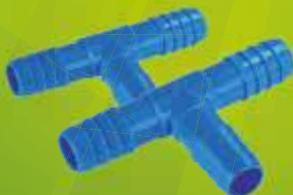

**União Interna:
3/8" a 4"**

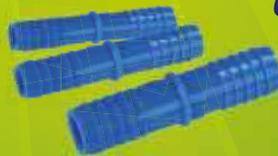

**O melhor
do plástico!**



TERMIFIN

**PRODUTOS INTELIGENTES
PARA O CONTROLE DE
PRAGAS URBANAS**

DEXTER
LATINA





BASSO PANCOTTE

Produtos para Agropecuária

Domissanitários



Código	Descrição	Cx.
37182	ATAK MATA BARATAS GEL 12X10G (FIPRONIL)	1



Código	Descrição	Cx.
38392	CITROMAX GEL PARA BARATAS 10G	36



Código	Descrição	Cx.
5949	STRAIK GEL MATA BARATAS 10 G	24



Código	Descrição	Cx.
11780	STRAIK GEL MATA BARATAS GRATIS GEL FORMIGA	24



Código	Descrição	Cx.
3482	TERMIFIN MATA BARATAS 10 g	12



Código	Descrição	Cx.
3486	TERMIFIN MATA FORMIGAS 10 g	12



Código	Descrição	Cx.
10308	BARAPIL PASTA BARATICIDA 10g DIPIL	48



Código	Descrição	Cx.
11614	BARATICIDA BARAPIL CAIXA 250x25g 6,250 Kg	1



Código	Descrição	Cx.
9513	BARATICIDA BARAPIL DISPLAY 2x60x25g 3 Kg	1



Código	Descrição	Cx.
27767	JIMO M. BARATA AEROSOL 300 ML CX C/6 UND	1



Código	Descrição	Cx.
28068	KAOCID GEL M. BARATAS 10 G	24



Código	Descrição	Cx.
28069	KAOCID GEL M. FORMIGAS 10 G	24



BASSO PANCOTTE

Produtos para Agropecuária

Domissanitários



Código	Descrição	Cx.
9819	MORTEIN AERO MATA BARATA 12X400ML EMB ECONOMOM	1



Código	Descrição	Cx.
35997	ATAK CUPINICIDA 200CE 06X1000ML	1
36189	ATAK CUPINICIDA 200CE 10X100ML	1
35998	ATAK CUPINICIDA 200CE 24X100ML	1



Código	Descrição	Cx.
10125	CITROMAX CUPINICIDA 24x100ML CIPER 25sc	1



Código	Descrição	Cx.
23299	JIMO CUPIM AEROSOL 400 ML CX C/6 UND	1



Código	Descrição	Cx.
5030	JIMO CUPIM BASE AGUA 500ml	12
9505	JIMO CUPIM BASE AGUA 900ml	12



Código	Descrição	Cx.
36241	JIMO CUPIM INCOLOR 5 L CX C/4 UNID	1



Código	Descrição	Cx.
36027	JIMO CUPIM INCOLOR 500 ML CX C/12 UNID.	1
36028	JIMO CUPIM INCOLOR 900 ML CX C/12 UNID.	1



Código	Descrição	Cx.
36029	JIMO INSETICIDA LIQUIDO 500 ML ESPACIAL CX C/12 UNID.	1



Código	Descrição	Cx.
10518	JIMO PROTECOLOR UV IMBUIA 900ml	6



Código	Descrição	Cx.
10517	JIMO PROTECOLOR UV IPE 900ml	6



Código	Descrição	Cx.
1386	CITROMAX CUPINICIDA Imidacloprid 1 L	12
1384	CITROMAX CUPINICIDA Imidacloprid 100ML	12



Código	Descrição	Cx.
37181	ATAK MATA FORMIGA GEL 12X10G (FIPRONIL)	1



BASSO PANCOTTE

Produtos para Agropecuária

Domissanitários



Código	Descrição	Cx.
38393	CITROMAX GEL PARA FORMIGAS 10G	36



Código	Descrição	Cx.
5948	STRAIK GEL MATA FORMIGA 10G	24



Código	Descrição	Cx.
3361	PASTA VERDE FORMICIDA 10g DIPIL	48



Código	Descrição	Cx.
37920	CITROMAX ISCA FORMICIDA 300g RESISTENTE UMIDADE	70



Código	Descrição	Cx.
37436	FIPROMIX 1KG (4 X 250G) CX C/12	1



Código	Descrição	Cx.
27676	GRAO VERDE FORM. 10x50g (500g) FIPRONIL 0,01%	40



Código	Descrição	Cx.
31695	GRAO VERDE FS FORM. 40 X 500G (10X50G) CAIXA 40 PACOTES	1



Código	Descrição	Cx.
32966	ATRATEX MATA FORMIGAS 5 G BLISTER	144



Código	Descrição	Cx.
5028	JIMO ANTI-FORMIGA BLISTER 1 UND	12



Código	Descrição	Cx.
38385	CITROMAX SPRAY 30ML	288
38386	CITROMAX SPRAY 50ML	144
38387	CITROMAX SPRAY 100ML	144
38388	CITROMAX SPRAY 240ML	12
38389	CITROMAX SPRAY 500ML	9



Código	Descrição	Cx.
4840	TERMIFIN FIPRONIL CE MULTI-INSETOS 50 ML	48
7013	TERMIFIN FIPRONIL CE MULTI-INSETOS 1000 ML	6
32978	TERMIFIN FIPRONIL CE MULTI-INSETOS 200 ML	12



Código	Descrição	Cx.
7600	TERMIFIN FIPRONIL READY 250ml SPRAY	24

Bio carb

AGROQUÍMICA





BASSO PANCOTTE

Produtos para Agropecuária

Domissanitários



Código	Descrição	Cx.
11895	TERMIFIN IMIDACLOPRIDO SC 50 ml	48
11896	TERMIFIN IMIDACLOPRIDO SC 200 ml	12



Código	Descrição	Cx.
34373	EXTERMIX SPRAY 30ML	50
34372	EXTERMIX SPRAY 60ML	50
34371	EXTERMIX SPRAY 100ML	50
34370	EXTERMIX SPRAY 240ML	12



Código	Descrição	Cx.
36400	FIPROMIX 100 ML CX C/24 (Fipronil 2,5%)	1
11841	FIPROMIX 6 X 1000 ML CX (Fipronil 2,5%)	1



Código	Descrição	Cx.
33858	K-OTHRINE 2P PO 1 KG (AZUL)	12



Código	Descrição	Cx.
27093	ATAK PO 400 20 X 500G CAIXA	1



Código	Descrição	Cx.
29034	MADEPO 50 20 X 1 KG (4X250G)	1



Código	Descrição	Cx.
25829	CUPROFIX 250G	24
493	CUPROFIX 30 G CALDA BORDALESA	60



Código	Descrição	Cx.
36188	GLIFOSATO BIOCARB 10X100 ML	1
36026	GLIFOSATO BIOCARB 06X1000ML (M.SAÚDE)	1
36025	GLIFOSATO BIOCARB 24X100ML M.S.	1



Código	Descrição	Cx.
36000	ATAK IMAZAPYR 2.5% 100ML 24X100ML	1
36186	ATAK IMAZAPYR 2.5% 10X100ML	1



Código	Descrição	Cx.
1387	CITROMAX GRAMIZAP 1 L	12



Código	Descrição	Cx.
7180	GLIFOSATO CITROMAX - JARD AMAD 100 ml	24
86	GLIFOSATO CITROMAX - JARDIAMAD 12X1000 L	1



Código	Descrição	Cx.
2664	GLIFOSATO CITROMAX - JARD AMAD 12X1000 ml	1
2659	GLIFOSATO CITROMAX - JARD AMAD 12X100 ml	1



BASSO PANCOTTE

Produtos para Agropecuária

Domissanitários



Código	Descrição	Cx.
10567	GLIFOSATO TERMIFIN HERBICIDA 1000ML PRONTO USO	12



Código	Descrição	Cx.
1354	GLIFOSATO DIPIL DISPLAY C/ 6 FR 20 ML	24



Código	Descrição	Cx.
4838	STRAIK MATA-CUPIM AEROSOL 12 x 400ml	1



Código	Descrição	Cx.
4836	STRAIK MULT INSETICIDA AEROSOL 12 X 450 ML	1



Código	Descrição	Cx.
11894	STRAIK MULT INSETICIDA AEROSOL 9 X 630 ML MEGA ECONOMICA	1



Código	Descrição	Cx.
31736	JIMO ACAROS-PULGAS AEROSOL 300ML CX C/6 UND	1



Código	Descrição	Cx.
32468	JIMO ANTI-INSET AEROSOL 300 ML CX C/6 UND	1



Código	Descrição	Cx.
371	JIMO ANTI-TRACA AEROSOL 300 ML CX C/6 UND	1



Código	Descrição	Cx.
23763	ALCANCE AER 400 ML REP. MARIMBONDOS	12



Código	Descrição	Cx.
37303	KIT LAR AEROSOL 300 ML	12



Código	Descrição	Cx.
38083	SBP AERO M INSETICIDA 6 X 380ML	1



Código	Descrição	Cx.
31729	STRAIK APARELHO ELETRIK	24



BASSO PANCOTTE

Produtos para Agropecuária

Domissanitários



Código	Descrição	Cx.
31728	STRAIK ELETRIK REFIL 20 CARTC/12 PASTIL	6



Código	Descrição	Cx.
10914	REPELENTE ELETRONICO FURACÃO PET BRANCO	1



Código	Descrição	Cx.
23289	JIMO ANTI-INSET APARELHO BIVOLT C/4 REFIL	12



Código	Descrição	Cx.
11903	JIMO ANTI-INSET REFIL 60 NOITES	24



Código	Descrição	Cx.
33636	JIMO ANTI-INSET KIT APAR + REFIL 60 NOITES	8



Código	Descrição	Cx.
23290	JIMO ANTI-INSET REFIL 20 X 12 PAST. CAIXA	5



Código	Descrição	Cx.
37741	JIMO ESPIRAL CX C/12UND	1



Código	Descrição	Cx.
9824	SBP LIQ ELET REF 35ML + AP GTS 45N	12



Código	Descrição	Cx.
4048	K-OTHRINE CE 6X250 ML CAIXA C/ 6 FR	1



Código	Descrição	Cx.
311	K-OTHRINE SC 25 30ML CAIXA C/100 UNID	1
36033	K-OTHRINE SC 25 30ML CX C/25 UNID.	1



Código	Descrição	Cx.
35518	TROPPER 2.5 F FIPRONIL 06x200 ml CAIXA	1



Acaba com os cupins e as brocas, e evita novas infestações.



Alta penetração e poder residual, protegendo e valorizando a madeira.



Apresentado em base água com nanopartícula ou base solvente.



LÍDER Nacional da categoria





BASSO PANCOTTE

Produtos para Agropecuária

Domissanitários



Código	Descrição	Cx.
36044	MALATOL CASA JARDIM SPRAY 12X500ML	1



Código	Descrição	Cx.
36125	MALATOL 500 CE 06X1000ML	1
36191	MALATOL 500 CE 10X100 ML	1
36043	MALATOL 500 CE 24X100 ML CX C/24 UNID.	1



Código	Descrição	Cx.
9509	CITROMAX TERMIMAX MALATHION 500 CE 24X100 ML	1



Código	Descrição	Cx.
29545	MADEPULGA 20 X 1 KG	1



Código	Descrição	Cx.
5032	MADEPULGA 2x12x50g (24 LATAS)	1



Código	Descrição	Cx.
10911	NEXXOR 100 SC 24 x 100ML DIPIL	1
11448	NEXXOR 100 SC 25 x 30ML DIPIL	1



Código	Descrição	Cx.
6844	TERMIDIL 200 SC 100ML	24
33921	TERMIDIL 200 SC 30ML	1



Código	Descrição	Cx.
9231	TERMIDIL 200 SC 6x1000 ML	1



Código	Descrição	Cx.
34832	JIMO OPEN AIR 300 ML CX C/6 UN	1



Código	Descrição	Cx.
10858	FORTIS 2,5 CS 30 ML	40



Código	Descrição	Cx.
609	BOLFO 1 KG	12
6821	BOLFO 200 G	24



BASSO PANCOTTE

Produtos para Agropecuária

Domissanitários



Código	Descrição	Cx.
4311	CITROMAX PO PULGA PM400 FIPRONIL 500g	40



Código	Descrição	Cx.
26760	DIAZITOP PM 25 G CX C/40 UND	1



Código	Descrição	Cx.
36056	TALFON TALCO 100 G (TUBO) CX C/24 UNID.	1



Código	Descrição	Cx.
1574	TALFON TOP 100 G CX C/24 (CARTUCHO)	1
36057	TALFON TOP 250 G CX C/20 (CARTUCHO)	1
36058	TALFON TOP 1 KG CX C/12 (CARTUCHO)	1



Código	Descrição	Cx.
36358	TALFON TOP 1 KG CX C/11 (EMB. ECONOMICA)	1
36359	TALFON TOP 250G CX C/44 (EMB. ECONOMICA)	1



Código	Descrição	Cx.
29265	TALFON TOP BALDE 20 KG (200X100G)	1



Código	Descrição	Cx.
929	TALFON TOP BALDE 20 KG (20X1KG)	1



Código	Descrição	Cx.
36793	TALFON TOP BALDE 20 KG (80X250G)	1



Código	Descrição	Cx.
26003	JIMO DEDETIZADOR 10G	6



Código	Descrição	Cx.
8443	JIMO GAS - CX 6 X 2 TUBOS 35 g	1



Código	Descrição	Cx.
8170	JIMO PO DOMESTICO 100 G ANTI PULGA	12



Código	Descrição	Cx.
25616	KAOCID PO 50G DISPLAY C/12 UNID.	4



BASSO PANCOTTE

Produtos para Agropecuária

Domissanitários



Código	Descrição	Cx.
24651	PULFO ANTIPULGA 100 G TALCO (TUBO)	24



Código	Descrição	Cx.
24477	PULFO ANTIPULGA 100 G	24
24478	PULFO ANTIPULGA 200 G	24
24479	PULFO ANTIPULGA 1 KG	12



Código	Descrição	Cx.
10523	PULFO ANTIPULGA 180X100G BALDE 18KG	1
24480	PULFO ANTIPULGA 20 X 1 KG BALDE 20KG	1



Código	Descrição	Cx.
32935	TALCO ANTI-PULGA DUCAO 120 Gr CX C/24	1



Código	Descrição	Cx.
7956	PULGOL 100 G CAIXA C/24	1



Código	Descrição	Cx.
7957	PULGOL 100 G TALCO CAIXA C/24	1



Código	Descrição	Cx.
7958	PULGOL BALDE (15 X 1) 15 KG	1
10315	PULGOL BALDE (150 X 100 Gr) 15 KG	1



Código	Descrição	Cx.
34775	TROFFEU 40PM INSETICIDA (25X40G) PO MOLHAVEI	1



Código	Descrição	Cx.
9510	CITROMAX TERMIMAX LAMBDA 10 PM 600g (24x25g)	4



Código	Descrição	Cx.
38338	LAMBDA MIX 10 PM (40x25g) DIPIL	1



Código	Descrição	Cx.
9234	LAMBDA MIX GARDEN 20x25g DIPIL	1



Código	Descrição	Cx.
37193	ICON 10 PM 10x25g	1



BASSO PANCOTTE

Produtos para Agropecuária

Domissanitários



Código	Descrição	Cx.
8766	CITROMAX INSETICIDA CIPERMETRINA 250ce 25% 12x1 L	1



Código	Descrição	Cx.
1646	FORMIMAX DEETIZAÇÃO 50ml CITROMAX 50ML	12



Código	Descrição	Cx.
1521	FORMIMAX DEETIZAÇÃO PLUS 200ml CITROMAX (Fipronil 2,5%)	12



Código	Descrição	Cx.
38504	ADUBO 04.14.08 DIMY (24X500GR)	1
38505	ADUBO 10.10.10 DIMY (24X500GR)	1



Código	Descrição	Cx.
38484	BRILHA FOLHA DIMY (OLEO MINERAL) 200ML	12
38483	BRILHA FOLHA DIMY (OLEO MINERAL) 50ML	30



Código	Descrição	Cx.
38485	BRILHA FOLHA DIMY (OLEO MINERAL) PRONTO USO 500ML	12



Código	Descrição	Cx.
38491	CUPRO DIMY 300G	10
38490	CUPRO DIMY 30G	30



Código	Descrição	Cx.
38492	CUPRO DIMY LIQUIDO 60ML	24



Código	Descrição	Cx.
38488	DIMY PRONTO C/ GATILHO 500ML	12



Código	Descrição	Cx.
38489	DIMYPEL 20G	30

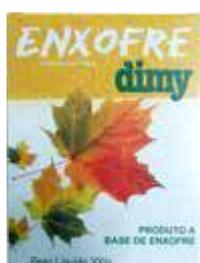

Código	Descrição	Cx.
38514	ENXOFRE DIMY (10X300G)	1
38503	ENXOFRE DIMY (30x30G)	1



Código	Descrição	Cx.
38493	ERVA SANTA DIMY PRONTO USO 500ML	12



BASSO PANCOTTE

Produtos para Agropecuária

Domissanitários



Código	Descrição	Cx.
38534	FARINHA DE OSSO DIMY (24X500GR)	1



Código	Descrição	Cx.
38598	FERTILIZANTE DIMY AZALEIA E ROSA 500G	10



Código	Descrição	Cx.
38594	FERTILIZANTE DIMY AZALEIA E ROSA 500G	12



Código	Descrição	Cx.
38556	FERTILIZANTE DIMY CASA VERDE FOLIAR 120 ML	12
38557	FERTILIZANTE DIMY CASA VERDE RAIZ 120 ML	12



Código	Descrição	Cx.
38595	FERTILIZANTE DIMY ORQUIDEA 500ML	12



Código	Descrição	Cx.
38596	FERTILIZANTE DIMY SAMAMBAIA 500ML	12



Código	Descrição	Cx.
38597	FERTILIZANTE DIMY TEMPEROS 500ML	12



Código	Descrição	Cx.
38599	FERTILIZANTE DIMY VIOLETA 500ML	12



Código	Descrição	Cx.
38501	FERTILIZANTE LIQUIDO 04.14.08 DIMY 120ML	12
38502	FERTILIZANTE LIQUIDO 10.10.10 DIMY 120ML	12



Código	Descrição	Cx.
38573	FERTILIZANTE ORQUIDEA LIQUIDO DIMY 250ML	12



Código	Descrição	Cx.
12449	FOSFATO MOIDO + FARINHA DE OSSO 1KG DIMY	12



Código	Descrição	Cx.
12450	FOSFATO MOIDO DE ROCHA 1KG DIMY	12

dimy®

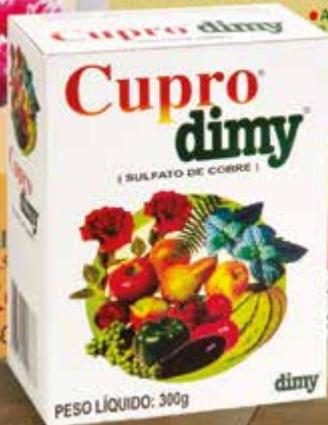



BASSO PANCOTTE

Produtos para Agropecuária

Domissanitários



Código	Descrição	Cx.
38487	OLEO VEGETAL DIMY 1000ML	12
38486	OLEO VEGETAL DIMY 100ML	12



Código	Descrição	Cx.
38494	PO DE FUMO DIMY 200G - ERVA SANTA	10



Código	Descrição	Cx.
38536	SALITRE DIMY (24X500GR)	1



Código	Descrição	Cx.
38506	UREIA DIMY (24X500GR)	1



Código	Descrição	Cx.
38535	VERMICULITA DIMY (12X2LT)	1



Código	Descrição	Cx.
38726	GIGAMIX PLUS - FERTILIZANTE MINERAL MISTO 100G	24



Código	Descrição	Cx.
36190	LESMAFIN 6X(4X250G)	1



Código	Descrição	Cx.
27677	MADELESMA 1 KG (4X250g) DIPIL	20



Código	Descrição	Cx.
10496	MADELESMA GARDEN 500g (10X50g)	20



Código	Descrição	Cx.
7378	MADELESMA RESIST. UMID. 20 KG BARRICA GRANEL	1



Código	Descrição	Cx.
9110	MADELESMA RESIST. UMIDADE 1 KG (4X250G)	20



Código	Descrição	Cx.
8617	LESMICIDA FERRAMOL ORGANIC 100% NATURAL 50 g	80



BASSO PANCOTTE

Produtos para Agropecuária

Domissanitários



Código	Descrição	Cx.
101	CITROMAX LEMICIDA 4 pct x 1 KG (4Kg) RESIS. UMIDADE	1



Código	Descrição	Cx.
8767	CITROMAX LEMICIDA RESITENTE UMIDADE SACO 20KG	1



Código	Descrição	Cx.
3499	TERMIFIN MATA-LESMAS 1 Kg 10x100g	6



Código	Descrição	Cx.
26548	SODA MADESODA 12X1 KG DIPIL	1



Código	Descrição	Cx.
104	CITROMAX AFASTA GATO POTE 300g	12



Código	Descrição	Cx.
11827	CITROMAX CITROPIROL Desalojante para Morcegos 200ml	12



Código	Descrição	Cx.
4276	CITROMAX XO PASSARO GEL 250g	24



Código	Descrição	Cx.
102	CITROMAX XO PASSARO POTE 300g 15 pastilhas	12



Código	Descrição	Cx.
32999	AFASTE PO 480 G REP. P/ POMBOS	12



Código	Descrição	Cx.
23790	REPELENTE AMER.THURSAN 220G	12



Código	Descrição	Cx.
1596	REPELENTE AMER.THURSAN 280G BISNAGA FLEX	12



Código	Descrição	Cx.
10503	CITROMAX CARTELA COLA MOSCA	50





BASSO PANCOTTE

Produtos para Agropecuária

Domissanitários



Código	Descrição	Cx.
38096	FITA PEGA MOSCA FLY TRAP PAPEL CX C/25 UNID	40



Código	Descrição	Cx.
38394	CITROMAX GEL PARA MOSCA 10G	12



Código	Descrição	Cx.
11794	FIM DA MOSCA THIAMETOXAN 10WG 6X100g	1



Código	Descrição	Cx.
24343	CERTRINE 255C 30 ML	1



Código	Descrição	Cx.
33806	MATA MOSCA DISPLAY 2x24X25G DIPIL	1



Código	Descrição	Cx.
9784	ATRATEX-G 25 Gr DISPLAY C/30 UNID	6



Código	Descrição	Cx.
10520	KAOCID MATA MOSCAS 25 G	240



Código	Descrição	Cx.
35336	RATOEIRA ADESIVA KRODEC GR 36,5 CM X 25,5 CM 31G	200



Código	Descrição	Cx.
36481	RATOEIRA ADESIVA KRODEC PQ 34CM X 25 CM	200



Código	Descrição	Cx.
8003	RATOEIRA ZINCADA GRANDE - ENCARTELADA	1
8004	RATOEIRA ZINCADA PEQUENA - ENCARTELADA	1



Código	Descrição	Cx.
29302	RATOEIRA ZINCADA GRANDE C/12 UNID.	10



Código	Descrição	Cx.
29303	RATOEIRA ZINCADA PEQUENA C/24 UNID.	16



BASSO PANCOTTE

Produtos para Agropecuária

Domissanitários



Código	Descrição	Cx.
37391	PORTA ISCA COMBAT RAT C/CHAVE	24



Código	Descrição	Cx.
9511	RATICIDA CITROMAX BLOCO TRIANG 4 Kg BARRICA 160X25g	1



Código	Descrição	Cx.
36037	RATICIDA M. RATO KOMBATE BLOCO PARAF. 6 X 1 KG (50x20g)	1



Código	Descrição	Cx.
36062	RATICIDA M. RATO KOMBATE GRAN. 6 X 1KG (40X25G)	1



Código	Descrição	Cx.
5289	RATICIDA KLERAT BLOCO 1 KG 50X20G	10



Código	Descrição	Cx.
24593	RATIC M RATO BIO CARB 1X(160X25G)4kg	1
36061	RATIC M RATO BIO CARB 3x(160x25g)	1



Código	Descrição	Cx.
37633	RATICIDA M. RATO BIO CARB RATICID GIRASSOL 3x(40x25g) 3 Kg	1



Código	Descrição	Cx.
3630	RATICIDA CITROMAX DE CEREAIS 1 Kg (40x25g)	10



Código	Descrição	Cx.
38391	RATICIDA CITROMAX DE GIRASSOL 1 KG	10



Código	Descrição	Cx.
10323	RATIC CITROMAX ROSA PELETIZ 10 Kg (400x25g)	1
10324	RATIC CITROMAX ROSA PELETIA 3 Kg (120x25g)	1



Código	Descrição	Cx.
28685	RATICIDA STRAIK ISCA M. RATO PREMIUM (40 X 25G) 1 Kg	6



Código	Descrição	Cx.
36052	RATICIDA STRAIK ISCA M. RATO PREMIUM (400 X 25G) 10 kg	1



EFICIÊNCIA COMPROVADA



☎ 49 3344 3087

🌐 citromax.ind.br

📷 Citromax

CITROMAX



BASSO PANCOTTE

Produtos para Agropecuária

Domissanitários



Código	Descrição	Cx.
10205	RATICIDA TERMIFIN ISCA ISCA M. RATO (40 X 25G) 1 Kg	6



Código	Descrição	Cx.
36006	BRUMOLINE ISCA 75 G EM CAIXINHA CX C/45 UNID.	1

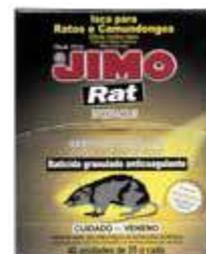

Código	Descrição	Cx.
28836	RATICIDA JIMO RAT DISPLAY 40X25g 1Kg	4



Código	Descrição	Cx.
8178	RATICIDA JIMO RAT ESTOJO 4X25g 100g	12



Código	Descrição	Cx.
4237	RATIC KLERAT MATA RATOS PELLETS 40X25g 1KG	10
8676	RATIC KLERAT MAT RATOS PELLETS 200x25g 5KG	2



Código	Descrição	Cx.
1388	RATICIDA RATAK 10 60X75g 4,5 Kg	2



Código	Descrição	Cx.
36193	RATICIDA M. RATO BIO CARB RATC PO 10X100G	1
36036	RATICIDA M. RATO BIO CARB RATC PO 12X200G	1
36035	RATICIDA M. RATO BIO CARB RATC PO 6X1000G	1



Código	Descrição	Cx.
4310	RATICIDA CITROMAX PO CONTATO 12X200g	1
4309	RATICIDA CITROMAX PO CONTATO 6X1Kg	1



Código	Descrição	Cx.
36443	RATICIDA COSMOS BR 200 G CX C/20 UNID.	1



Código	Descrição	Cx.
37488	RATICIDA M. RATO KYRRATY 100 GR - CAIXA C/ 30 UNID	1



Código	Descrição	Cx.
686	RATICIDA RI DO RATO 100 G	24
36050	RATICIDA RI DO RATO 200 G CX C/12 UNID.	1



Código	Descrição	Cx.
9196	REPELENTE ELETR RATOS E INSETOS PRETO FAZENDEIRO	30



BASSO PANCOTTE

Produtos para Agropecuária

Domissanitários



Código	Descrição	Cx.
29691	ESPANTA RATO/MORCEGO ERMU-1/5 "CENTRAL"	1



Código	Descrição	Cx.
29692	ESPANTA RATO/MORCEGO ERMU-UR U.REMOTA	50



Código	Descrição	Cx.
7210	OLEO DE NEM 1,2% 100 ML CURSOR BIOCARB	24
7212	OLEO DE NEM 1,2% 500 ML CURSOR BIOCARB	24



Código	Descrição	Cx.
10504	CITROMAX CARTELA PEGA RATO	12



Código	Descrição	Cx.
10505	CITROMAX DOMESTICO SPRAY 100ml DELTAMETRINA	12



Código	Descrição	Cx.
10508	CITROMAX FITA COLA MOSCA 78cm C/4 UNID	24



Código	Descrição	Cx.
10509	CITROMAX FORMICIDA PO 40 ROSA FIPRONIL 1 KG	20



Código	Descrição	Cx.
10510	CITROMAX FORMICIDA PO 50 ROSA DELTAMETRINA 1 KG	20



Código	Descrição	Cx.
10511	CITROMAX GRAMIZAP MAX 20 1 L	12



Código	Descrição	Cx.
10515	CITROMAX ISCA FORMICIDA FORMIMAX 500g	40



Código	Descrição	Cx.
10513	CITROMAX PO PARA BARATA 10g	12



Código	Descrição	Cx.
10514	CITROMAX PO PULGA PM400 FIPRONIL 100g	24



BASSO PANCOTTE

Produtos para Agropecuária

Domissanitários



Código	Descrição	Cx.
10507	CITROMAX SPRAY PLUS 5% 50ml	12
10506	CITROMAX SPRAY PLUS 5% 500ml	9



Código	Descrição	Cx.
10516	CITROMAX XO RATO 300g	12



Código	Descrição	Cx.
10512	GLIFOSATO CITROMAX - HERBICIDA 50ML 19%	24



Código	Descrição	Cx.
10124	OLEO DE NEEM ORIGINAL NEEM 100ML CITROMAX	24



Código	Descrição	Cx.
32921	OLEO DE NEEM 1,2% 100ML NEENMAX	24
37289	OLEO DE NEEM 1,2% 250ML NEENMAX	24
32922	OLEO DE NEEM 1,2% 1 L NEENMAX	12



Código	Descrição	Cx.
4287	CITROMAX XO MOSQUITO 150g	12



Código	Descrição	Cx.
7601	REPELENTE ALTOFF LOCAO 100ML	12



Código	Descrição	Cx.
8801	JIMO REPEL LOCAO REPELENTE 100ML	6



Código	Descrição	Cx.
10572	REPELENTE DE INSETOS 150ml REPELLERE	12



Código	Descrição	Cx.
4874	REPELEX AERO FAMILY CARE 200ML	12



Código	Descrição	Cx.
35561	REPELEX SPRAY FAMILY CARE 100ML	12



Código	Descrição	Cx.
37199	REPELENTE INSETPROTEC AEROSOL 200ML/146G	12
37200	REPELENTE INSETPROTEC LOCAO 100ML	12



BASSO PANCOTTE

Produtos para Agropecuária

Sumário

Table listing various agricultural products such as CRAVO COBRA, DUCHA MASTER BANHO, ESFREGÃO MULTI, FERRADURA, etc., with corresponding page numbers ranging from 132 to 170.

Linha de Utensílios

Facas de Cerâmica



- ✓ *Cortes precisos*
- ✓ *Fios mais duráveis*
- ✓ *Super leves*
- ✓ *Não enferrujam*
- ✓ *Não absorvem odores*
- ✓ *Design inovador*

 **BASPAN**



Central de atendimento ao cliente Basso Pancotte:
0800 724 1170



bassopancotte.com.br

